



VOODOO

EXPOSED!



FALL 2007

VOL. 93 ISS. 2

MIT: INVENTING A BETTER FUTURE

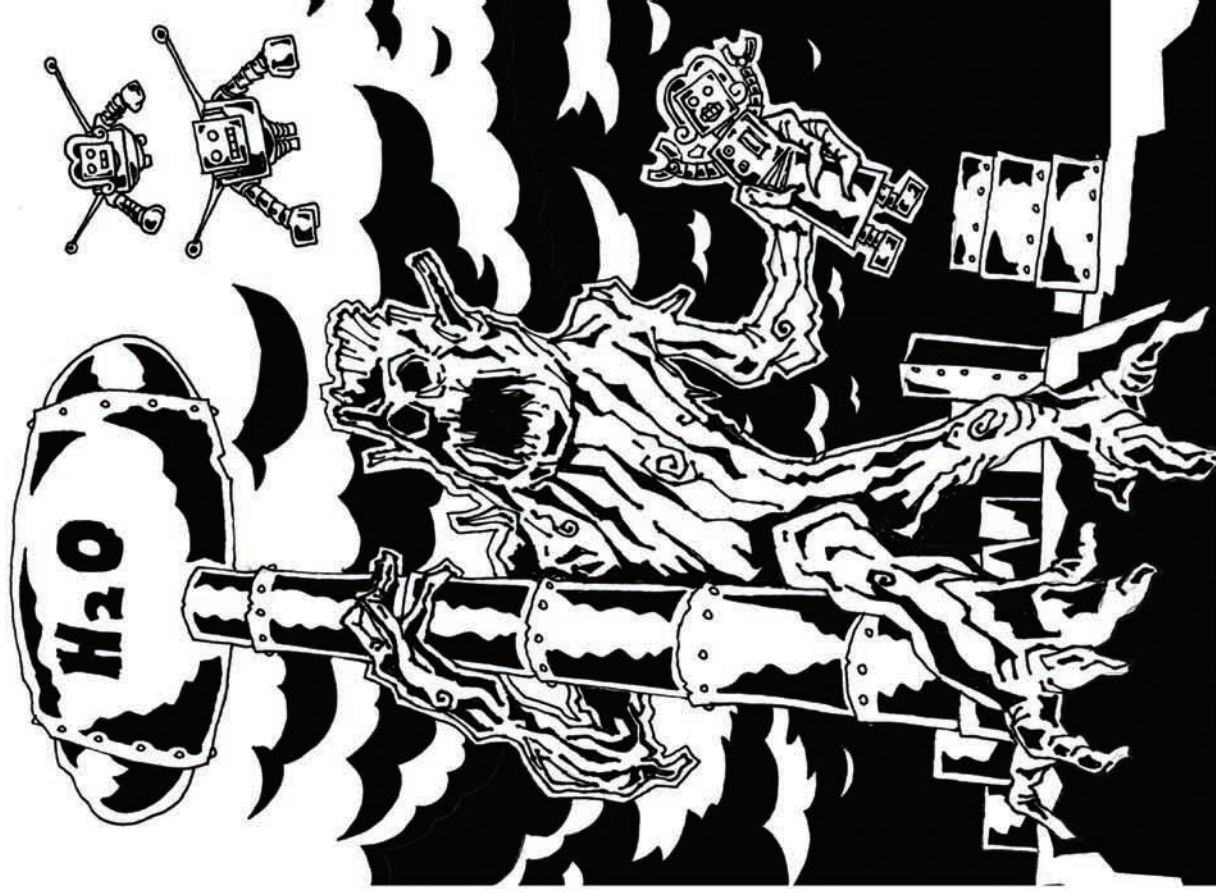
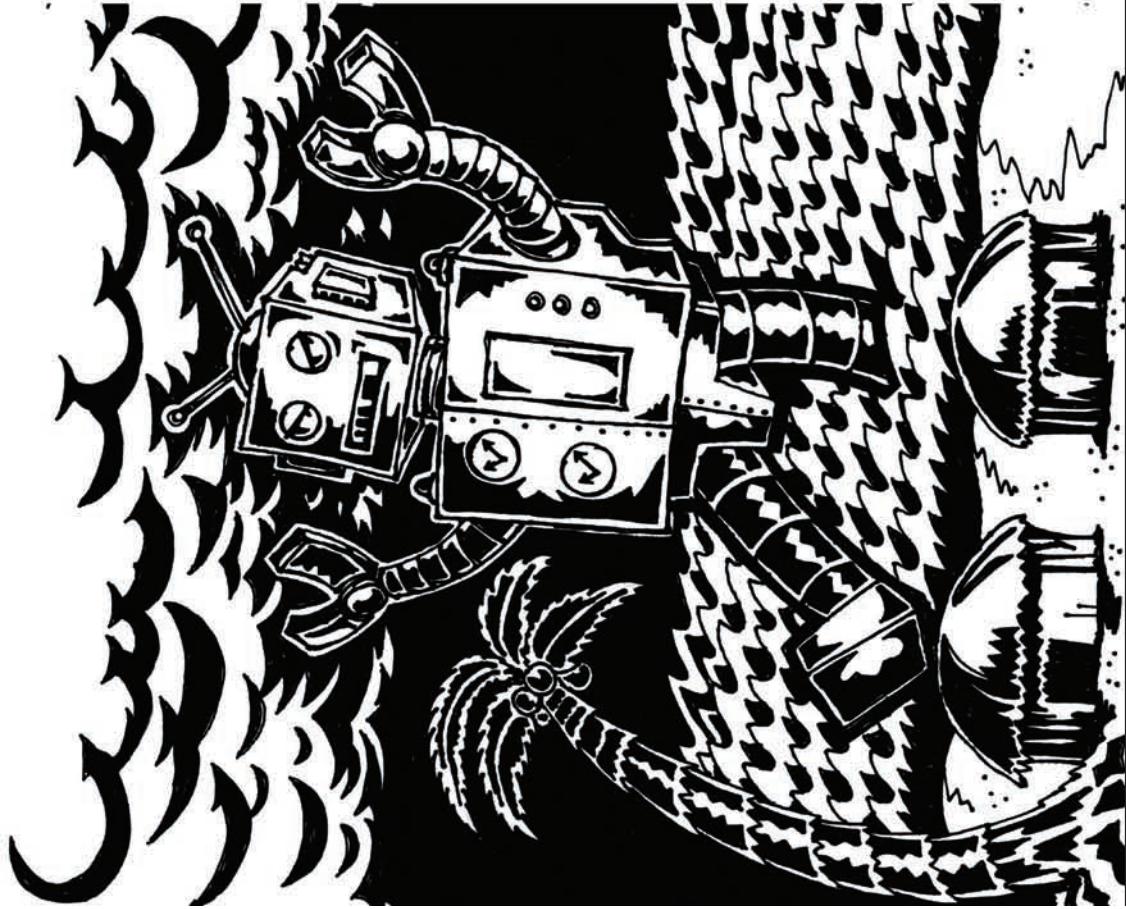

So what you're probably missing here, is that "Inventing a Better future" is the Media Lab's new tagline, and everyone loves laughing at the Media Lab. In the pictures we see technology that isn't quite making life better for the world, and within that contradiction we find humor. Maybe humor is just your brain saying "does not compute" in a funny language. In any event, when you have drawings this good, who cares what they're saying.

THE LONE VOO DOO OF THE APOCALYPSE

LETTERS TO THE GUEST EDITOR	PAGE 6
EMMACOMICS	PAGES 8-9
THE DAILY VOO DOO	PAGES 10-11
VOO DOO LOVES ROBOTS	PAGE 12
NEW YORKER STYLE COMICS	PAGE 13
THE AMOROUS ADVENTURES OF BARNACLE BILL	PAGES 14-15
END OF DAYS	PAGE 17
BILLY WAS THE FIRST PANTOMIME CAGE DANCER	PAGES 18-19
MORE NEWS!	PAGE 20
VAGINAL ADVENTURES @ MIT	PAGES 22-23
MORE EMMACOMICS	PAGE 24
PENGUIN COMICS	PAGES 27
VOO DOO HUMOR CONTEST	PAGE 29

This is our favorite page to lay out. We don't have to be funny or draw or write or think... And please don't ask why the comic below is funny if you don't get it. We're not allowed to say.

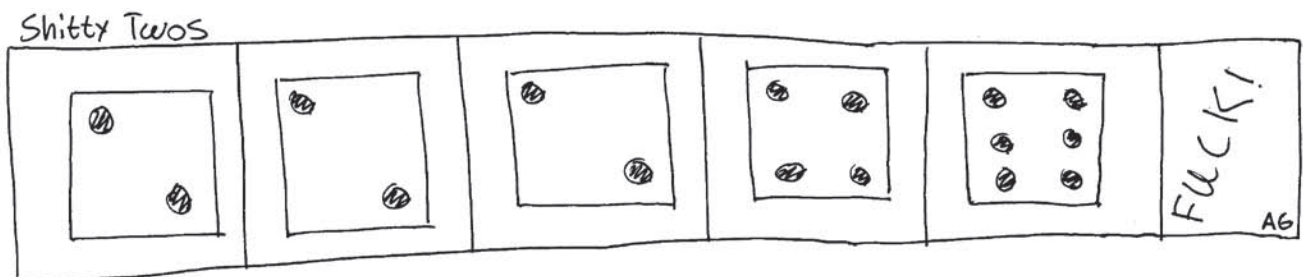

From the Publisher



Minister of Magic

Sarah Ackley

High Inquisitor

Mark Feldmeier

Supreme Mugwump

Clayton Sims

Head of Magical Law

Enforcement

Laura Nichols

Chief Warlock of the

Wizengamot

Alyssa Wright

Senior Undersecretary

Emma Lindsay

Publisher

Phosphorous

Contributors

Sarah Ackley
Paresh Agarwal
Beth E Baniszewski
Kim Beder
Matt Faulkner
Mark Feldmeier
Alex Guerra
Nick Harrington
Emma Lindsay
Neal Miller
Laura Nichols
Brian Pepper
Alec Resnick
Clayton Sims
Adele Schwab
Mark Tobenkin
Alyssa Wright
Yoyo Zhou

Volume 93, Number 2

Voo Doo Magazine
MIT Room 50-309
77 Massachusetts Avenue
Cambridge, MA 02139

voodoo@mit.edu

Voo Doo, MIT Journal of Humor, (ISSN 1066-2499) is published by Phosphorus Publishing whenever we can get our act together. All material ©2007 Voo Doo Magazine and individual authors. Single copy price \$2, six issue mail subscription \$10. Submissions accepted from any past-or-present MIT affiliate. Advertisers: write for rates, page sizes and production deadlines. Any similarity to persons living or dead without satirical intent is coincidence. Voo Doo is not printed on recycled paper due to concerns about the environmental impact of the “de-inking” process, but is printed with soy-based inks so if you chew it long enough, it tastes like tofu. Special thanks to the UA FinBoard for financial support. Printed at Turley.

Voo Doo (voo'doo) n., [Slang c.1920] hubbub; excitement; mischief; *an ideal name for a humor magazine*

This is the fingerprint. The fingerprint really isn't all that interesting. You probably don't want to read the fingerprint. Actually, I know you don't want to read the fingerprint. You won't like the fingerprint. Please don't read the fingerprint. There is nothing to see here. Move along. The fingerprint is a waste of your time. You will not like the fingerprint. As a matter of fact, you will find the fingerprint downright disgusting. Do something else, rather than read the fingerprint. So this is where we usually put a horrible description of utter filth and debauchery, but we'll let you fill in the blank this time. Phos now owns your soul. The fingerprint does nothing for you. The fingerprint leaves you feeling empty. There is no point in reading the fingerprint. The fingerprint merely wastes your time. You really shouldn't read the fingerprint. You are better than those sorts of people that read the fingerprint. The fingerprint is just a series of really small and insignificant words. You won't even stoop to admitting that the fingerprint exists. This is the fingerprint.

Check out the Voo Doo Magazine Homepage
and the College Humor Magazine Homepage

<http://web.mit.edu/voodoo/www>
<http://web.mit.edu/voodoo/chm.html>

EDITORIAL

This is a very special issue of Voo Doo. More special than your “differently abled” little brother. You might even laugh for the first time ever while reading Voo Doo. In this issue, we’ve gone to the enormous effort of explaining to you humorless bozos why we think all the shit submitted to Voo Doo is actually worthy of being put in print (or why it isn’t). While reading this very special issue, look for writing in black boxes. I know it’s small and that you usually only look at the pictures in Voo Doo before putting it in the trash can (Come on, recycle People! Do it again! Like in that dumb song about recycling my mom used to sing to me when I was a kid.). But the fineprint is the only thing that actually makes this issue worth reading. Without it, this issue is only a bunch of shitty drawings on paper towels done by sketchy 5th-easters. And no one, I mean no one, wants to read that kind of garbage.

This issue of Voo Doo has been a life adventure for me. It’s had it’s ups and downs, but in the end it’s been a big learning experience. Late nights in the Voo Doo office, desperately emailing my lazy-good-for-nothing friends to actually submit something funny or something other than a dumb drawing, taught me about the value of perseverance. Without it, this issue of Voo Doo would be full of all the filthy trash that fills my and Waffleman’s heads. Oh wait... it is! Even I was offended by some of the trash that came out of my ass at 6 A.M. this morning.

This issue of Voo Doo has also taught me about the value of teamwork. That’s right, because there is no I in “my kid has cancer.” Or at least that’s what’s written in the bathroom next to 433 in Senior Haus. And by teamwork here I don’t really mean team work. I mean that Waffleman told me what to do and what to write. And I did what he told me out of some dumb sense of obligation. After all, I did say that I’d be willing to be layout bitch over the summer. And I am a woman of my word and I am completely regretting it. I should serve as a warning to the rest of you. Never ever agree to edit Voo Doo. Unless you like the idea of submitting yourself fully and totally to Waffleman. I guess there are a few of you out there that probably already jerk off about that sort of thing.

There are several people I should thank for making this issue of Voo Doo possible. First of all, I should thank myself. Without me, there would’ve

been no one to be layout bitch for Waffleman. God forbid, he might have actually had to lay out the issue himself. I think I was also a last resort for this sort of thing because I’m not very good at being funny. When I was a kid I always felt really uncomfortable when people told jokes because I’d never get them. I’d either have to ask what was funny, at which point everyone would point and laugh at me, or I would just pretend to laugh, which made me feel like a complete and total loser.

I’d also like to take this opportunity to thank MIT chancellor Phillip L. Clay for being the guest editor for this issue’s letters to the editor. Phillip L. Clay has been a ideological role model for me while at MIT. He’s always encouraging people to be the best possible people they can be. Those emails about reconsidering our community values and the importance of honesty and integrity always move my bowels greatly.

This issue also wouldn’t have been possible without the numerous quality submissions we received. Unfortunately, some of them just weren’t funny at all and regrettably were deemed too crappy even for Voo Doo’s low quality standards. We at Voo Doo would like to thank everyone who submitted. Even if your submission wasn’t accepted, please try to submit again. Next time, spend more than 5 minutes making your submission, actually try to be funny, and if you don’t know how to be funny just write or draw something vulgar. We at Voo Doo don’t get laid enough and love that vulgar shit. It’s the only way we get off.

Best of luck on finals everybody, although saying that is completely meaningless because half of you will get bad grades no matter what! Hey, at least the Marilee Jones’ admits are bringing down the curve for us losers and nerds who actually deserve to be at this shithole of an Institvtpe for higher bullshit.

-SFA

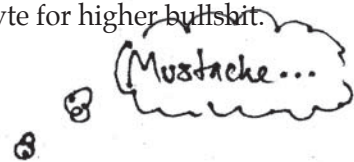

LETTERS TO THE GUEST EDITOR

For this issue of Voo Doo, MIT Chancellor Phillip L. Clay has agreed to be a guest editor.

*Sincerely,
Phos*

Dear Editor of Voo Doo,

I am writing in regards to your last issue, in which you depicted a ten story tall robotic version of the Stata Center attacking the MIT community. As a result of your slanderous campaign, MIT has chosen to take legal action against my client, Frank O. Ghery. The building was not found to be faulty until you pointed out its dangerous effects in your publication. As a result, we will be bringing a civil suit against you for defamation of character, loss of revenue, and emotional hardship. My client is no longer able to twist broken pieces of paper into architectural masterpieces, and his dog fluffy is having nightmares.

Mr. Rap N. Pillidje
Attorney at Law

Dear Mr. Rap N. Pillidje,

Thank you for your note regarding Frank O. Ghery and the incident regarding the MIT Stata Center. Let me first say that I regret how the matter is being characterized in the media. Many of the reports are unfair to Frank O. Ghery and do not reflect the facts

or our view of him. We do not believe Frank O. Ghery is a dangerous or malicious person or that he intended to cause harm. I appreciate how tough it is to read these stories and hear the comments.

That said, we do understand the sensitivity about protection from robot attacks. We expect that architects will appreciate that what might be acceptable on the set of the recent film Transformers would not be acceptable on a college campus. We further expect that this appreciation would be reflected in appropriate judgment and restraint in settings like college campuses where there are clear rules. We all exercise this restraint and thoughtfulness about security standards every time we go to college campuses, particularly in this era after the 9/11 attacks. We rely on others to respect the standards as well. Part of the media reaction to an architect in this situation is that those who are "wowed" by the great things associated with MIT every day cannot understand why our architects do not understand and respect the college campus security standards that everyone else respects, despite considerable inconvenience, for the safety of the greater public.

MIT has a long tradition of encouraging its architects to be creative and to explore paths that others might not. Good science and good scholarship requires this. We will

continue that tradition. We are also required, however, to remind architects that certain public standards have to be respected lest transgressions of them be judged as reckless.

*Sincerely,
Phillip L. Clay*

Dear Voo Doo,

I am having trouble sleeping at night. I keep having these crazy dreams of being molested by MIT Administrators. And they don't use condoms. I am afraid I am going to become pregnant with their illegitimate bureaucratic child, and my parents will disown me, and no longer pay my tuition. I will be forced to drop out of MIT and work at McDonald's. What's worse, since my child will have been the offspring of an administrator, it will be deformed and retarded, placing an extra burden on me to supply it with the red tape and buzzword meetings it will need to survive in this harsh world. What should I do?

Frank Ghery's Dog

Dear Frank Ghery's Dog,

I am responding to you about an important matter -- protecting our celebrated traditions while taking full responsibility for our actions. As members of the MIT com-

munity, administrators must be committed to both. You have raised legitimate concerns, and it has become clear that administrators need to reaffirm core principles and sharpen their commitment to their obligations.

We cannot deny the fact that what was tolerated in the past, and may even have been celebrated, is now viewed differently. Times have changed. Those administrators who violate tradition, by endangering themselves or others, by breaking the law, by molesting students, cannot seek protection from responsibility, and they will be held accountable for their actions. We will ensure that any unlawful action against you will be punished.

While our disciplinary system can and will hold administrators accountable, our pride and discipline are a far more reliable means to preserve and advance our community. I ask for your cooperation and support in celebrating and protecting our traditions, taking responsibility, and upholding integrity. I welcome suggestions for how we can make the response to these challenges a community project with students taking a leadership role. Doing that will model the leadership we all want our administrators to claim and will be the source of great pride.

*Sincerely,
Phillip L. Clay*

To the Editor of Voo Doo,
I'm not sure whom I should bring this issue to, as everyone else I've consulted about it has told me to stop being such a bigotted pig. But there is this real dog in one of my classes, and I don't just mean your standard MIT woman, I mean a real dog, ARF ARF. It smells awful, barks at inopportune times, and is often foaming at the mouth. It has this crazy look in its eyes, like it hasn't slept in weeks, I think it might try to kill me. My professor threatened to call the deans if I make disparaging comments to it anymore, but it just doesn't seem to respond to SIT and HEEL. It also got a higher score on the midterm and is bringing up the class average.

Desperate for Help
Sloan E.

Dear Sloan E.,

I urge you to reconsider our community values. We are committed to creating and sustaining a community that is diverse in many important ways: in race and ethnicity, in gender, and in economic, cultural, and national backgrounds. While we have much to celebrate in these domains, we must continue to explore how we can do better and how we can maintain an environment in which we can all thrive and in which we can take pride. Your efforts to

advance diversity, in your student communities and in your relationships, are important contributions to our community.

*Sincerely,
Phillip L. Clay*

voo doo,

is the apocalypse near, you can tell me, i wont tell anyone else, i just need to know, so i can stock up on stuff, like guns and shit, you know, to keep all the radioactive queers away, they steal my stuff, like my butter, so i cant make toast, and then i have to use axle grease, which doesn't set well in my stomach, unless i eat ball bearings as well, but that's to be expected, don't worry, i wont tell anyone, its just you and me till the end baby.

crackhead2008@gmail.com

Dear Crackhead,

Over the next few days, we will provide a number of venues to discuss the apocalypse and related matters. I invite those of you with concerns about the apocalypse to take advantage of these opportunities to take part in an important community dialogue. Respect for free expression is an important value in our community, and benefits all of us.

*Sincerely,
Phillip L. Clay*

Seriously, if we have to explain how these things work, then you really are one of Marilee Jones's mistakes. Although if you could explain to us why they are funny, it would be much appreciated.

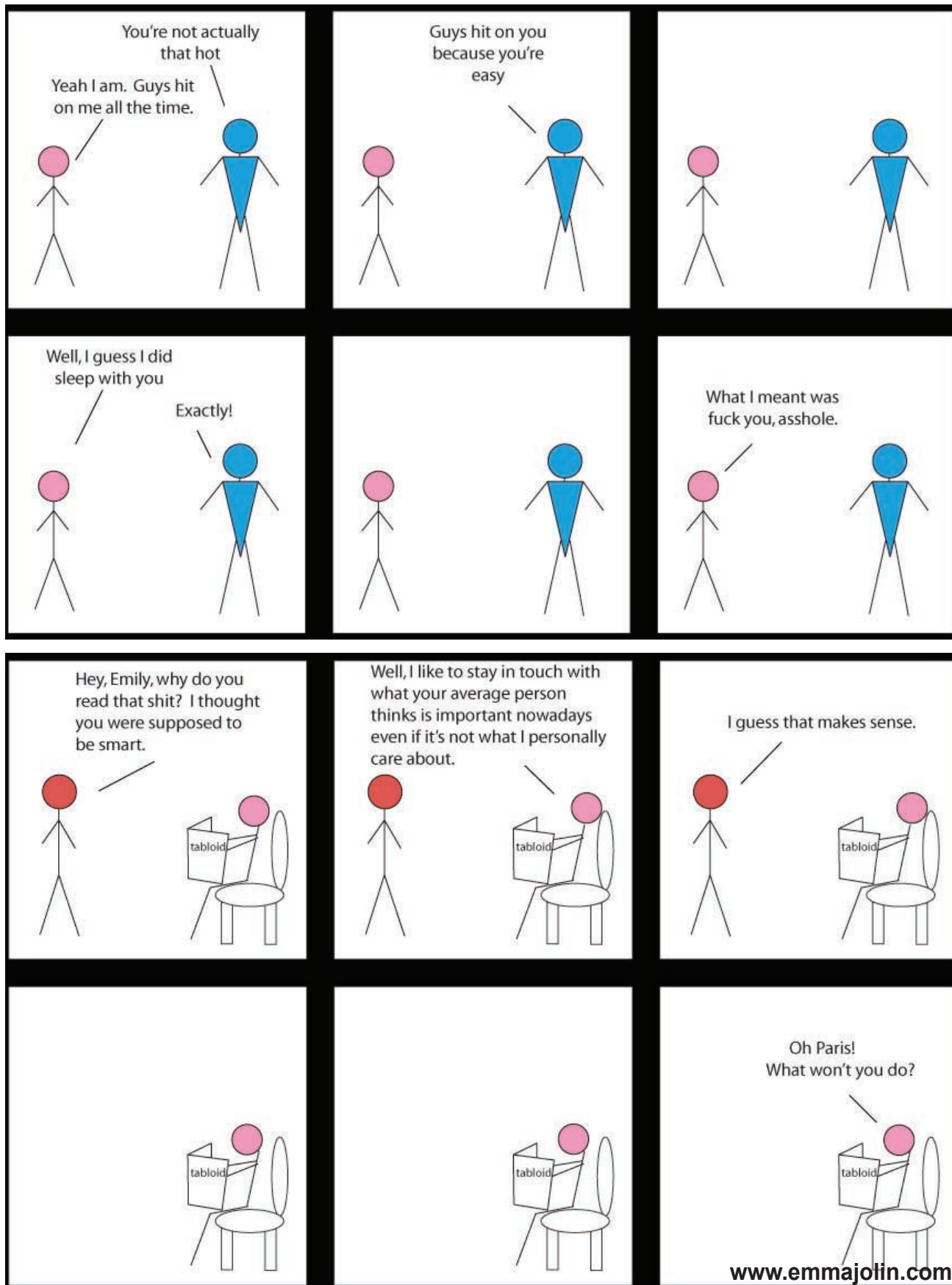

This is here just to show you, that all you need to know is Microsoft Paint, and you too can be a comic genius. Hey, why not put them up on the web and be famous?

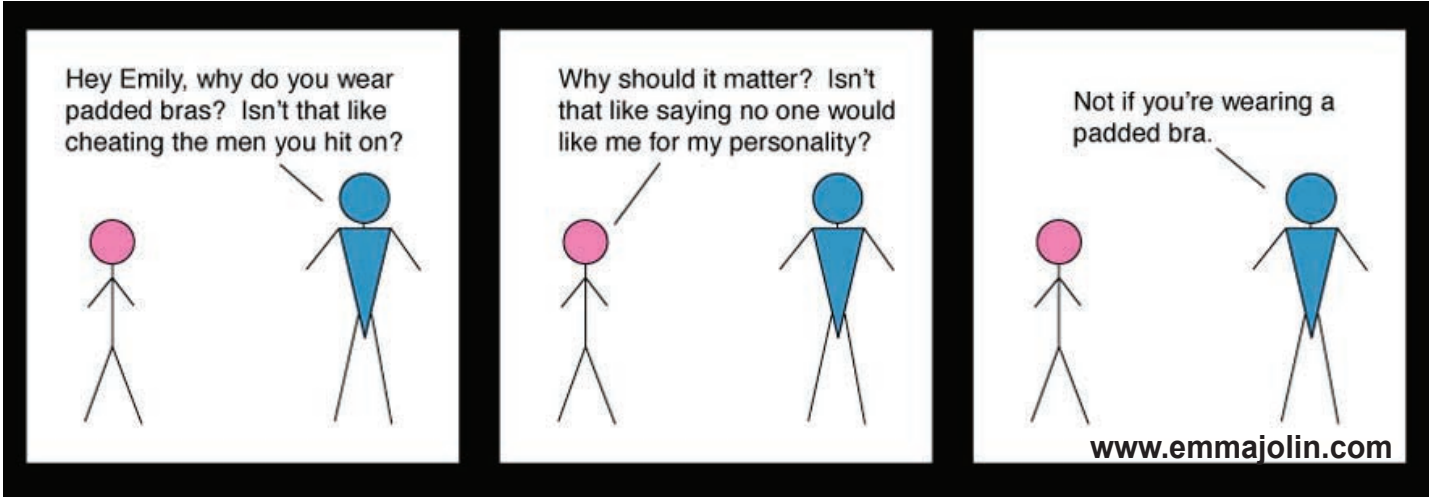

Holy Shit! There's color! Damn, what should we put here? I don't know, how about the color comics? Ah, you guessed it, you 1600 SAT spanker. That's what all this stuff has in common. Sometimes we don't have any color comics, so we photoshop some color in, in big splotches all over the place. Gotta get your money's worth!



LSAT
GMAT
GRE
MCAT
SAT
TOEFL

Tighter asshole. Brighter future.

Find out more about how testing screws over education, and tell us what you think!
1-800-KAP-TEST | kraplan.mit.edu

KAPLAN
TEST PREP AND ADMISSIONS

This service is a registered trademark of Kaplan International Education, Inc. ("Kaplan") and its affiliates. ©2007 Kaplan International Education, Inc. All rights reserved. Kaplan International Education, Inc. is an Equal Opportunity Employer. The Kaplan Group operates in the United States and Canada.

THE DAILY VOO DOO

MIT'S SECOND MOST
BLOATED AND OBNOXIOUS
NEWSPAPER

FORMER SLOAN PROF. STAGES OWN SHOOTING

Phosphorus T. Cat
NEWS EDITOR

A Sloan professor was shot in a parking lot after being exposed to radiation at the nuclear reactor. Supposedly, it was the doing of the professor's own son, a noted Colombian drug mule, who fled to Mt. Holyoke and died in the wilderness after being stabbed by his ex-girlfriend, who proceeded to bring LEDs to the airport while going to meet her boyfriend, who had actually fallen off a roof in New York City to his death. She got arrested machine gun-style for a “hoax device,” and was found dead in the trunk of a car under mysterious circumstances. The DA claimed it was a suicide, but her father, who was injured when cleaning up taffy-like sodium in the Charles, denied it. He left a message saying he was going to deal with some sketchy people in East Cambridge he hoped to never see again and then went missing; his dead body washed up in Cape Cod. The DA expressed relief, and then died in what police say was a drug-fueled sex bash after assaulting a woman leaving a party on Amherst St. When police searched his crystal meth/date rape drug manufacturing hideout, they discovered that the woman turned out to have been the Sloan professor, and that she filed a false police report.

TICKER-TAPE PARADE FOR WELLESLEY STABBER

Phosphorus T. Cat
NEWS EDITOR

Confetti cascaded from windows above. Church bells rang. Marching bands played. And the crowds cheered as 20-year-old Anna Tang came into site. Released on bail and ready to date, Anna Tang made her first parade along Wellesley's “Canyon of Heroines”, where hundreds of women congregated to pay her homage.

During the lobster banquet to celebrate Tang's

return, Wellesley President Kim Bottomly said role models are critically important for young women, especially role models who highlight nontraditional opportunities.

“For girls to dream beyond the narrow ideas of men, girls need the courage of women like Anna Tang.”

Visibly moved by the show of support, Tang said it was something truly indescribable to be a role model for so many. “I stabbed because of myself, but I had no idea I was stabbing for so many.”

3.091 INTRODUCES OVERFLOW-OVERFLOW ROOM

Phosphorus T. Cat
NEWS EDITOR

With students in 3.091 outnumbering seats in 10-250 and 26-100, course administrators have decided to introduce an overflow-overflow room in the alley behind building 26.

There are currently 1200 students in 3.091 and only 450 seats in the lecture room 10-250 and 566 seats in the overflow room 26-100, according to Christopher D. DiGuardia of the Registrar's Office.

Another solution would have been to move lectures for the class to the larger Kresge Auditorium, but that “would cramp my style,” said Sadoway. He said he thinks there is no way he can lecture effectively in “that Kyke Kresge's auditorium.”

Room 10-250 fills up at 9:45AM, about an hour and 20 minutes before the start of class, according to Prof. Sadoway.

Adum Frosh '11, a 3.091 student who attended the video streamed lecture yesterday in the back alley behind building 26, said, “At least I can smoke during lecture. Plus I can copy psets off the drunk homeless guy who usually sleeps in the alley.”

STUDENT SUPPORT SERVICES CALLS ON CRAIGSLIST TO HANDLE END-OF-TERM MENTAL HEALTH CRISIS

Phosphorus T. Cat
NEWS EDITOR

As the end of term nears and exams bear down on students at MIT, Student Support Services (S^3) posted on Craigslist this week in order to hire fifteen more, full-time “counselors” to deal with what Dean Henderson calls, “the yearly mental health meltdown at MIT.” Advertising for “literate, soft-spoken men and women,” S^3 asked that all applicants, “be ready to go through the motions of caring about students’ lives” and “comfortable with signing baseless claims of depression and emotional distress.”

Dean Henderson said that at first, S^3 was pleasantly surprised with the volume of inquiries. After weeding out responses with “pix of [their] manhood” and offers for “c i 4 l i s && MegaDik,” S^3 was left with a pool of fifteen applicants which was further winnowed to three people passing the obligatory SORI/CORI background checks.

In the past, Dean Henderson says that S^3 has handled the 481% jump in requests for notes and excuses has been handled by secretaries bcc’ing one of four form letters to professors. “We had four options: mental health issue, family concern, sexual crisis, and fellow student emergency. Last year, we actually had our first veritable medical concern in three years: someone came down with botulism.”

When word of this practice reached the CAP, Professor Kai von Fintel rushed to criticize the CAP, saying that “the fucking pansies in S^3 constantly get in the way of kicking students out of MIT. You know there are guys who wear earrings there?”

Reacting to the criticism, this year S^3 has been forced to implement a new system for handling the semiannual deluge. “If Craigslist doesn’t come through,” said Dean Henderson, “we’ll probably ask the faculty to serve part-time. That’ll teach them to stop being assholes about extensions and workloads.”

DECLINING DOLLAR CAN’T BUY SHIT: LOCAL HORTICULTURISTS FEEL THE PINCH

Phosphorus T. Cat
NEWS EDITOR

The plummeting value of the dollar against foreign currencies has been a source of worries for international companies doing business in dollars and for American tourists traveling abroad. But local gardeners are also running into trouble as they find their dollars worth less and less every day.

“I used to buy this shit from Germany—Scheiße brand, really nice stuff—but the exchange rates to Euros are just killing me,” said Fred Cameron, who describes himself as an avid gardener. Cameron has since switched to an option that’s closer to home.

“My neighbor Jack has his own farm that his family’s been taking care of for generations,” noted Cameron. “Nowadays I just go over there and pay him a couple bucks and take his shit right off his hands. Stuff works alright on my plants.”

Because of the increasing costs of farm supplies from overseas, however, Cameron may soon find himself out of luck. Cameron complained that his neighbor had recently raised his prices, lamenting, “I already can’t afford Scheiße brand, and soon I might not even be able to afford Jack’s shit!”

News continued on page 20

This one is pretty self explanatory. All you have to do is pick up a copy of The Tech (which is a joke in and of itself) and rearrange the headlines. The humor practically writes itself. Our goal is to get at least one funny thing said per sentence, but this usually just leads to run-on sentences, so we end up relying on the fact that no one actually “reads” Voo Doo, sure, people look at the pictures, and maybe if the font is bigger than 16pt it might get skimmed, but I can rest assured no one will ever think less of me for what I type here. Low pressure, that’s the upside of writing for Voo Doo.

VooDoo LOVES ROBOTS

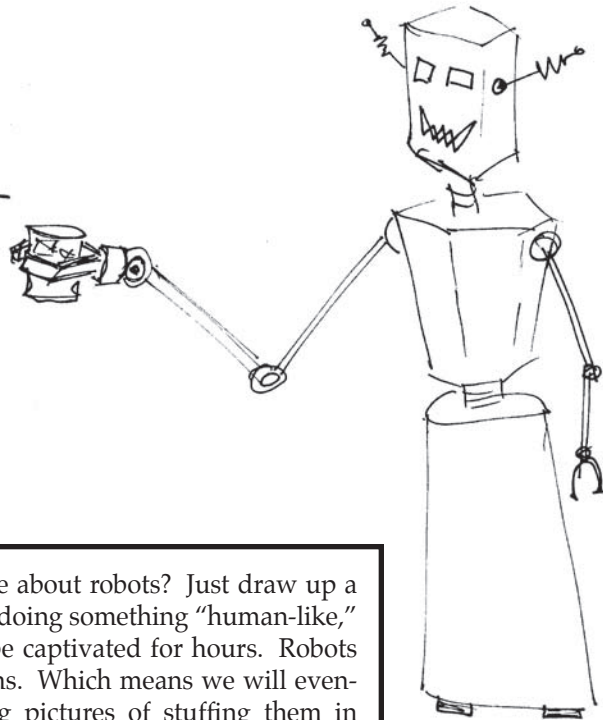
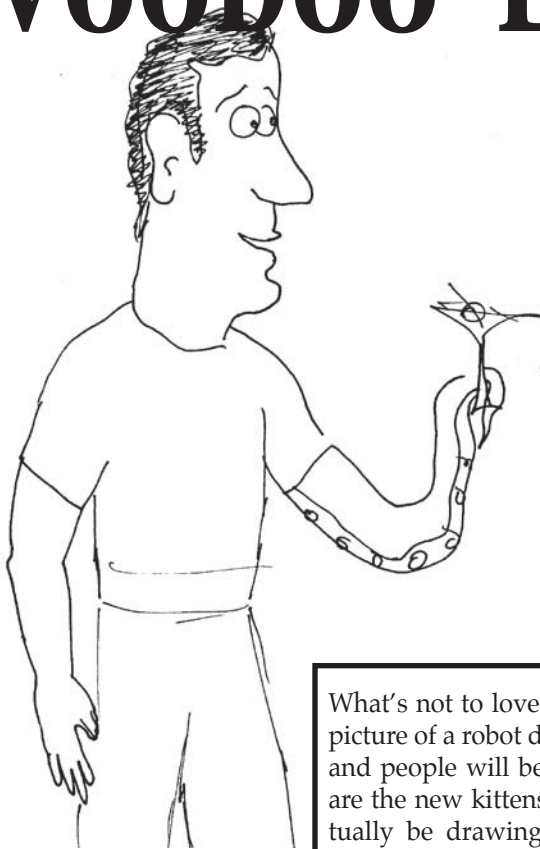

What's not to love about robots? Just draw up a picture of a robot doing something "human-like," and people will be captivated for hours. Robots are the new kittens. Which means we will eventually be drawing pictures of stuffing them in blenders. I guess all fads must come and go.

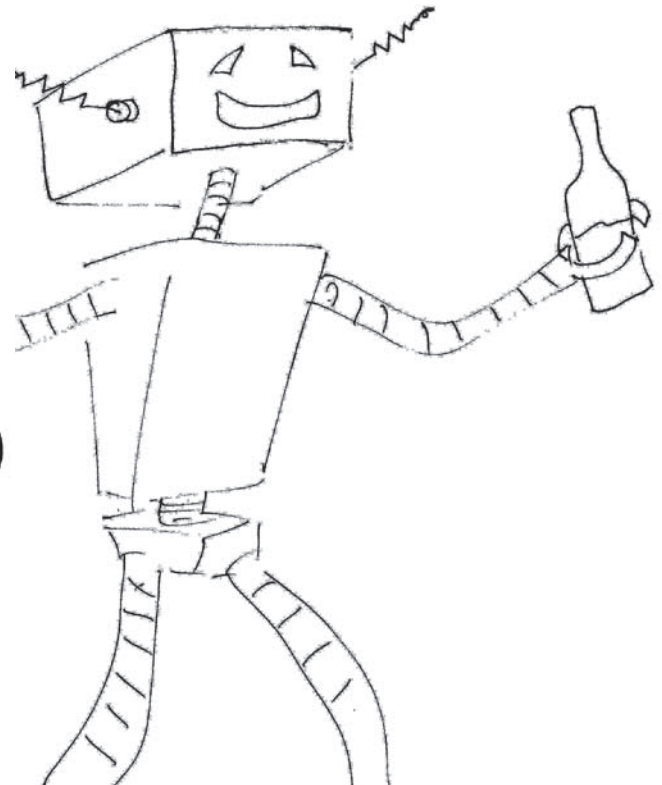
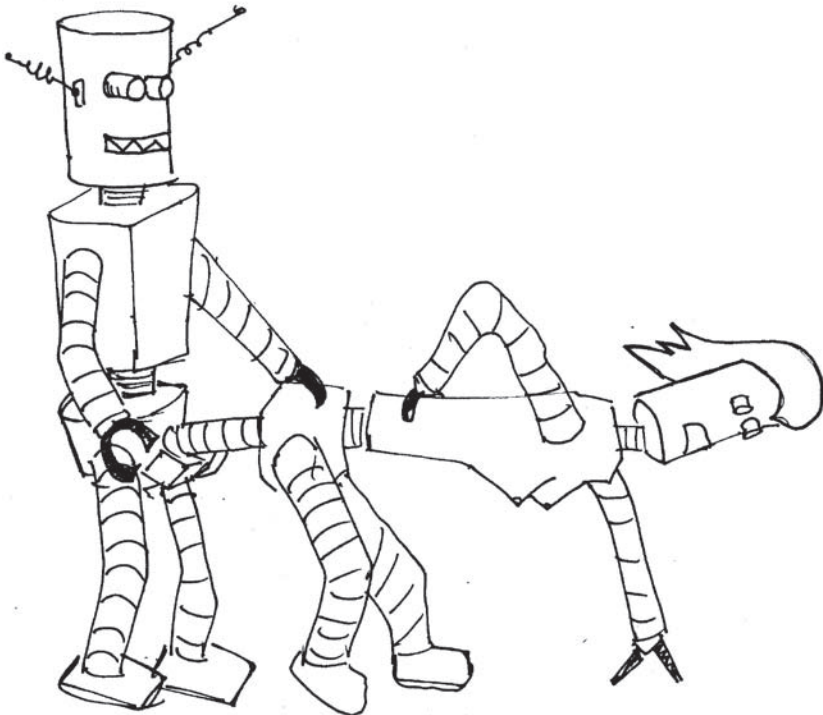

MIT Dining finally discovers how to be profitable.

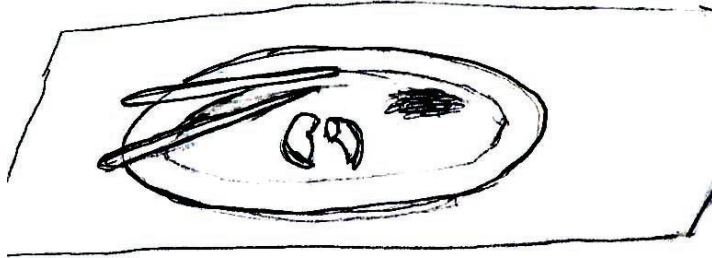

For antidote try tomorrow's orange chicken. Only \$64.

MIT food sucks. No wonder they're not making money. They never seem to get that improving the food might actually increase dining hall profits. I suppose poisoning might work as well...



Get it? If you've been drinking a lot of coffee (with the caffeine), you're probably all jittery and fucked up, so those curvy lines will seem all straight. For those of you who aren't addicted yet, the words on the cup say: IF YOU CAN READ THIS, SWITCH TO DECAF. Sure, we could have edited to be more legible, but in the end, fuck you.

Why geeks shouldn't grow up to be proctologists.



This is funny because it exemplifies how scatter-brained, geeky doctors can scare the hell out of patients. Good bedside manner means never using the word "blasters" in front of a patient, especially when the patient is being anally probed. I guess this is also funny because colonoscopies are inherently funny. I mean, even just the thought of anal probing is funny. Wait... I ought to be more careful. Colonoscopies are important. Come on! They fucking save lives. So when you get old and your anus is covered in hemorrhoids, get some anal probing or you'll die!

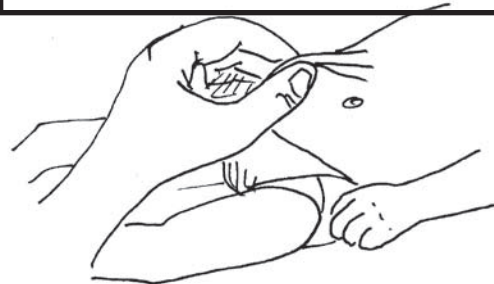

The skin of a properly dehydrated specimen remains elevated after being pulled up and released.

Come on! Who doesn't love a good dead baby joke? Or even a bad one? Plus this issue of Voo Doo doesn't have any abortion jokes, so we had to do something to offend people who think babies and fetuses actually deserve to live.

The Amorous Adventures of Barnacle Bill

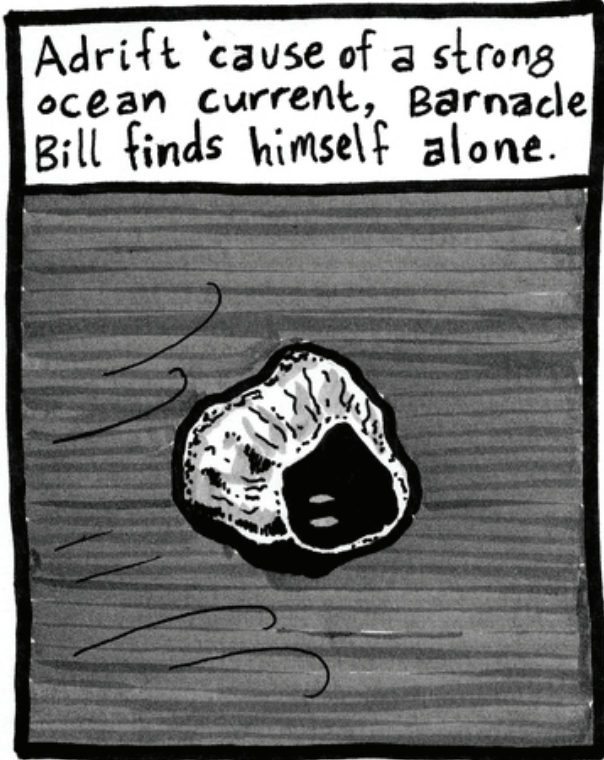

The real trick to being Voo Doo Editor, is finding people with talent and a guilty conscience. You can get so much wonderful material out of them before they go insane. Like these. You like puns, right?



The Amorous Adventures of Barnacle Bill



The Amorous Adventures of Barnacle Bill



LEARN TO READ*

* IF YOU CAN'T READ THIS YOU'RE FUCKED.

DID YOU KNOW

More than 4.5 million adult engineers are functionally illiterate?

Illiteracy is often passed from one generation to the next?

Illiterates (like you) have lower confidence and self-esteem?

Illiteracy costs this country an estimated \$12 billion in annual prison costs?

CALL TODAY!

GARBLEDYGOOK
1-888-567-TRUTH

GARBLEDYGOOK
1-888-567-TRUTH

GARBLEDYGOOK
1-888-567-TRUTH

GARBLEDYGOOK
1-888-567-TRUTH

GARBLEDYGOOK
1-888-567-TRUTH

GARBLEDYGOOK
1-888-567-TRUTH

GARBLEDYGOOK
1-888-567-TRUTH

GARBLEDYGOOK
1-888-567-TRUTH

GARBLEDYGOOK
1-888-567-TRUTH

GARBLEDYGOOK
1-888-567-TRUTH

GARBLEDYGOOK
1-888-567-TRUTH

GARBLEDYGOOK
1-888-567-TRUTH



smell. yourself.



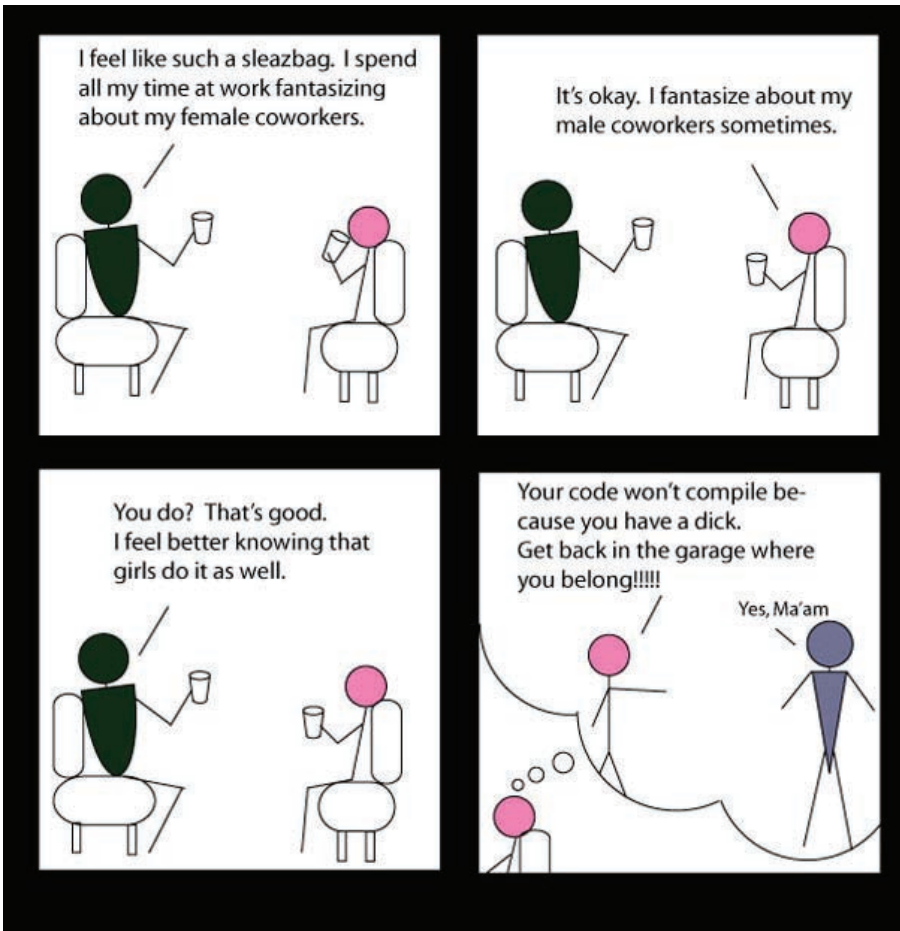

Who doesn't want to make fun of the French? Those un-American bastards don't support the Struggle for Iraqi Freedom and therefore deserve to be blown to bits with our nuclear bombs. Haha. Another blow job joke. Get it?

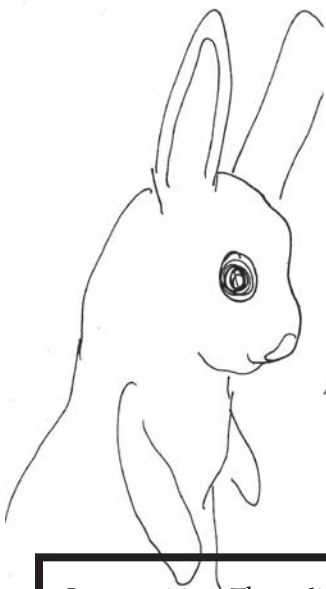

**IN THE END OF DAYS,
THE VOICES OF DARKNESS WILL
SING THE SONG OF UNDOING, AND
ALL JOY SHALL DEPART FROM THE
LAND. THEN YOU WILL KNOW THAT
I AM LORD, AND DESPAIR SHALL
REIGN ETERNAL.**



Juxtaposition. The disgusting and the profane. Abortions, Nazis, and waterboarding. Take any of these and slap them next to a cute and cuddly what-have-you, and what you have is instant humor. Its like cialis for shitty comics. Bring me my tub of vaseline, I've got an issue to get out! Oh boy, do we ever have issues here at Voo Doo. My therapist says that this is good for me.



BILLY WAS THE FIRST PANTOMIME CAGE DANCER

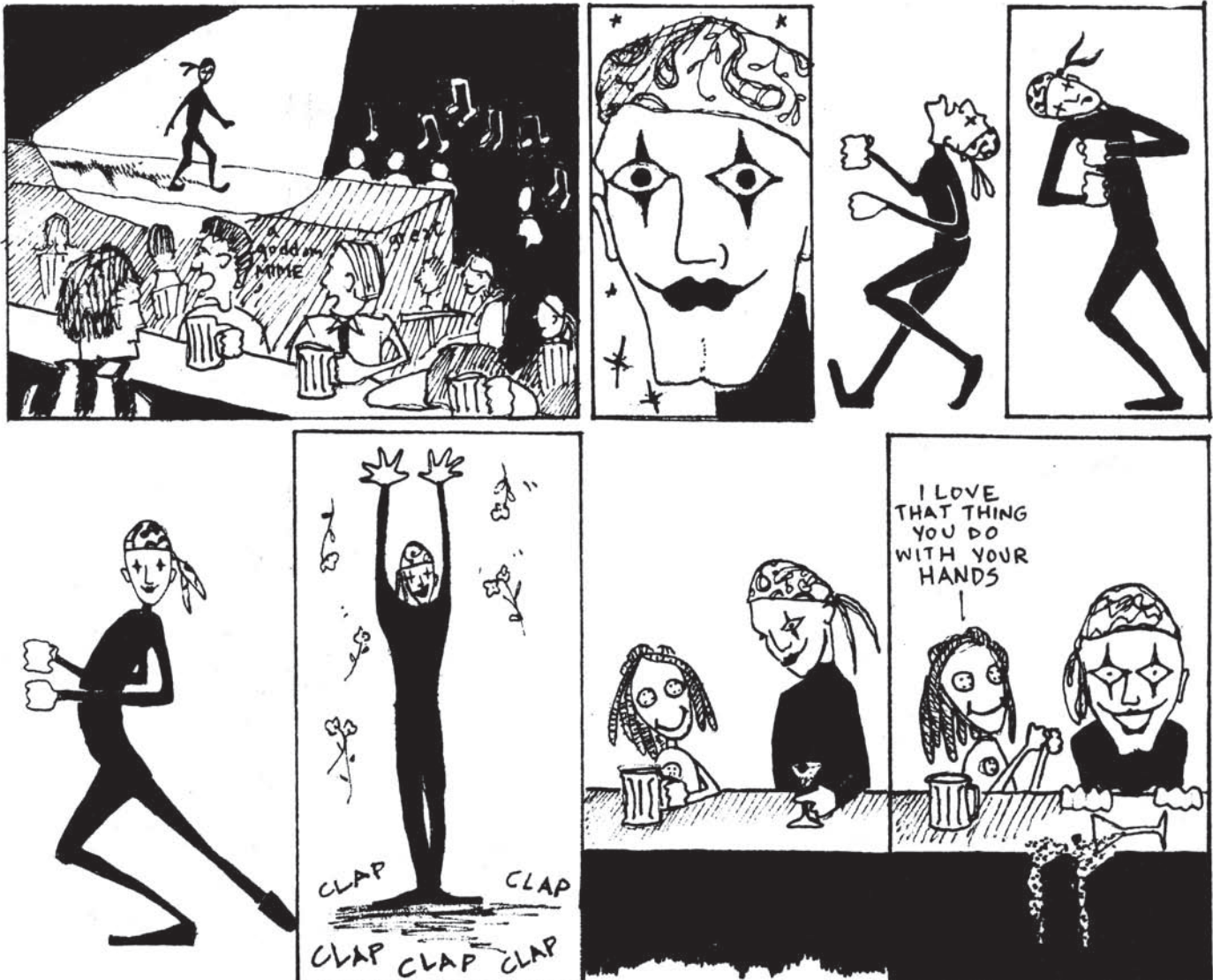

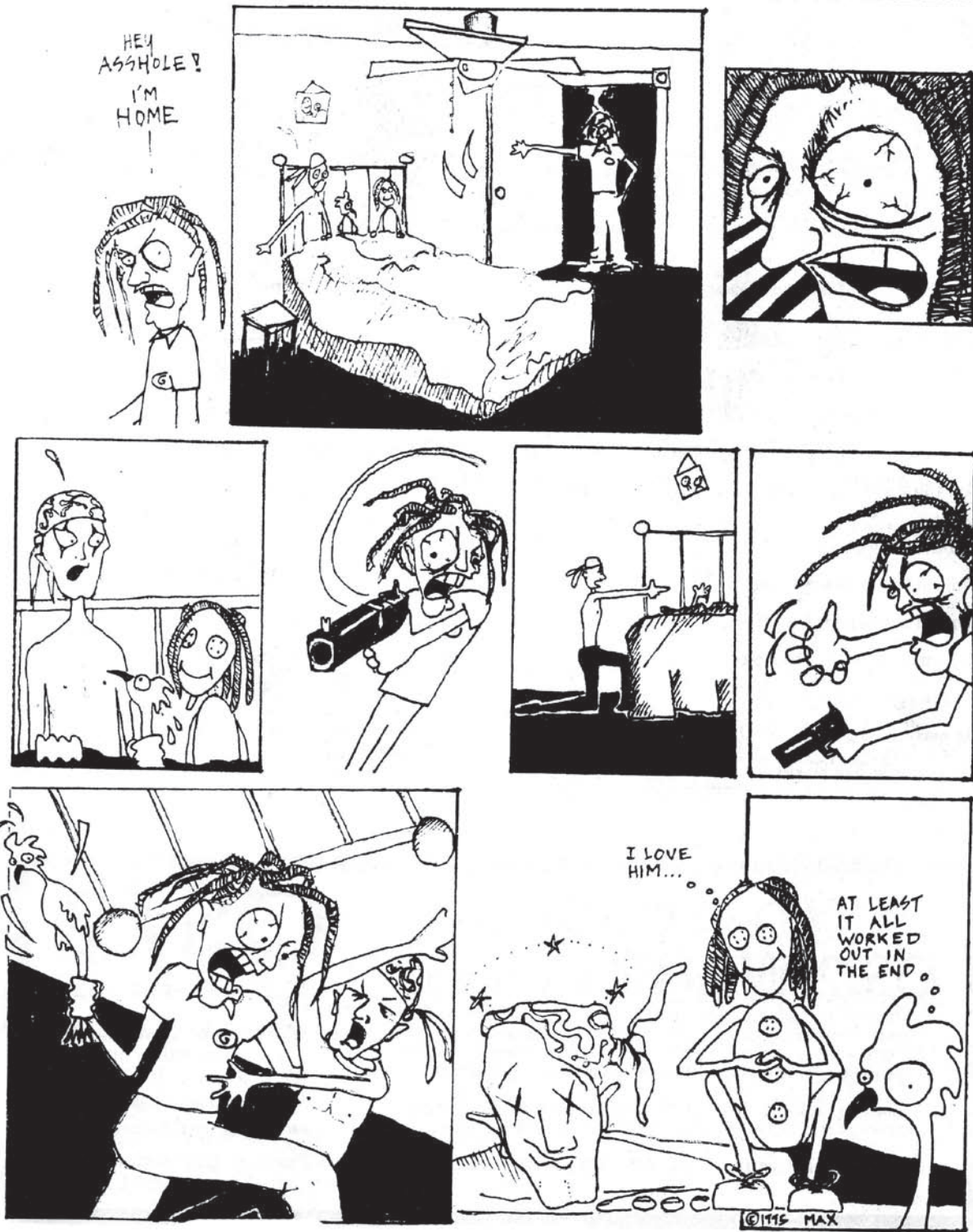

Every so often you will be reading Voo Doo and will stop and ask yourself, "what the fuck is going on here? this isn't all that funny." Well, you've probably just stumbled upon the inside joke section of Voo Doo. These comics are usually funny to about two or three people. But, hell, that's the whole Voo Doo staff, so what do we care? This particular inside joke has something else going for it, it's also a recycled comic. Yes, this fine drawing appeared in the Fall 1995 issue of Voo Doo. So, for its 12th year reunion, we've decided to let it see the light of day again. Actually, we just needed to fill up more space, but we like to tell lies her at Voo Doo. Can you tell who this inside joke is making fun of? If so, you're probably a towers alum. Congratulations, you're still alive!

OMG! MORE NEWS! HELLS YEAH!

CAP COMMISSIONED TO DRAFT NEW EDUCATIONAL MISSION

Phosphorus T. Cat
NEWS EDITOR

The Committee on Academic Performance (CAP) came out with a comprehensive guide last Tuesday for undergraduates concerned about how to best manage their grades. The accompanying email asked for applications from students for “representatives to serve on a committee that will be responsible for determining the direction MIT will take in undergraduate education in the coming years.”

Professor Kai von Fintel, Director of the CAP, said that the project idea came to him after dealing with one too many students who thought that the purpose of grades was to give feedback to teachers, reflecting how much students actually learned in class. “That’s a load of crap,” von Fintel said. Pushed further, von Fintel referred to assistant Hollis Lilly’s words, “The idea of academic credit and what appears on a transcript of one’s academic career is that there is not just a record of what courses a student has successfully completed but also a record of what courses a student has attempted but failed. [...] Learning the material and working through a class is irrelevant. What we’re really interested in is how effectively you can organize into ‘study groups’ to split up the workload of a problem set. Or how good you are obfuscating the illicit sources of your copied problem set answers.”

The new committee will be responsible for drafting an official statement of MIT’s pedagogical position, to “make sure everyone’s on the same page.” If you’re interested in applying, write to Professor von Fintel at fintel@mit.edu.

PROFESSOR HATES GRADES; HATES STUDENTS MORE FOR NEEDING THEM

Phosphorus T. Cat
NEWS EDITOR

A recent survey of professors at MIT revealed something surprising: they hate grades, too. 78% of respondents affirmed that they would abolish grades, on two conditions: the administration allowed it, and students still cared about their work. “I started teaching a class without giving problem sets, and by the third week, I was receiving complaints from students that they weren’t doing any work for my class, because I wasn’t forcing them to. Jerks. So what could I do? I added in problem sets and exams and now I have to do more work, but they’re happier. Supposedly. But still I hear them complain about the problem set at the beginning of class!”

Another professor commented that she found it unlikely that the type of student who gets in to MIT would be capable of teaching themselves anything without a carrot or stick to nudge them along. “Look at all the MEng’s! For most people, you know what that says? ‘Graduation rolled around and I didn’t have a fucking clue what I wanted to do. I guess I’ll do more school!’”

Listen, we all hate grades. Why are we still using them? Can you feel good about yourself without getting A’s? Can you feel good about yourself without having something to constantly bitch about? Can you choose classes without worrying about which one’s will look good on your transcript? At least Sloanies are explicit about their prudentialism.

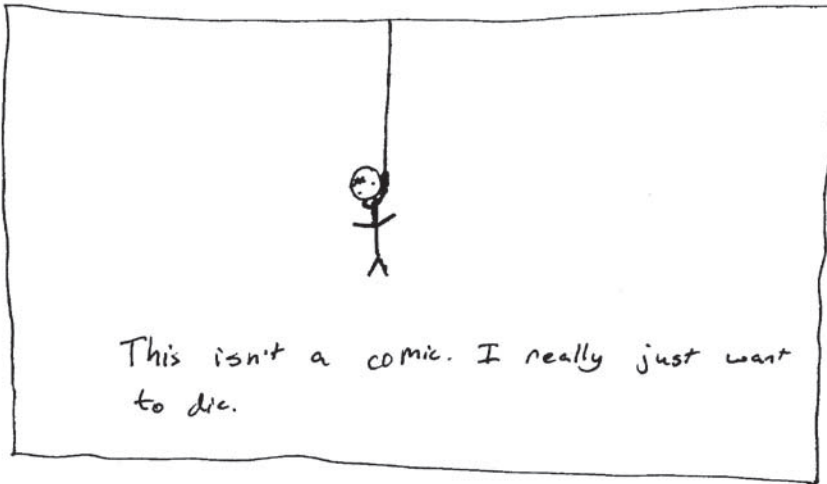

Nothing is easier around MIT than suicide (humor). It falls in to that "it's funny because its true" category. Just draw some wrist slitting, pill popping, nitrous suffocating loser, and add a tagline. Hell, take a tagline from a Wheaties commercial, THEY'RE GRRRRREAT!

O.K., we are seriously fucked in the head, and its either this, or beating small children waiting in line to see Santa Claus at the mall: YOU'RE GETTING THIS BECAUSE YOU'VE BEEN A BAD BOY THIS YEAR - SANTA HATES YOU AND ON CHRISTMAS MORNING HE'S GOING TO KILL YOUR PARENTS - MAYBE YOU'LL THINK TWICE BEFORE SASSING BACK TO YOUR TEACHER NEXT TIME! The muppets made me do it. Ever since I was a young child, the muppets would tell me to do things. Fucking Sesame Street, that deranged pervert Big Bird had me giving blow jobs to stray dogs in the park. So fuck them, it's payback time.



At night, the MUPPETS come

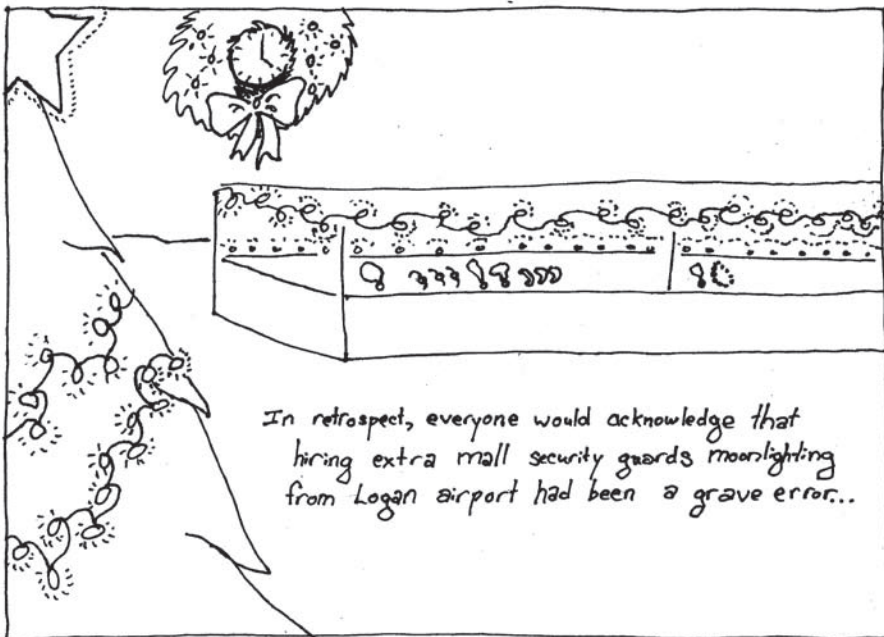

I guess mall jokes are all the rage these days with the recent Omaha mall shooting. Or maybe the author is saying that if security guards at Logan airport were hired at malls they would flip out at all the LED shit during the holiday season. After all, LED=bomb. But I'm confused, because as far as I can tell there are no such grave consequences depicted. Maybe this comic would be funny if we imagine a whole bunch of innocent people in the foreground being raped with machine guns. Or maybe the author was just drunk while writing this comic or was about to draw more when another human being actually invited him/her to have sex for the first time in over a year.

VAGINAL ADVENTURES @ MIT

O.K., I'm sure you've had to go to MIT Medical at some point. So even if you don't find this funny, you can at least be thankful that someone is making fun of those retards. The majority of the fodder for our humor cannons comes from the ass-backwards way things are run around the Institute. Ever since Chuck Vest decided to re-engineer this place over a decade ago, its been nothing but a downhill slide into a manure pile. Which makes life a little easier for us in the humor department at Voo Doo magazine. The Institute is essentially one big joke these days, so all you have to do is document what you see.

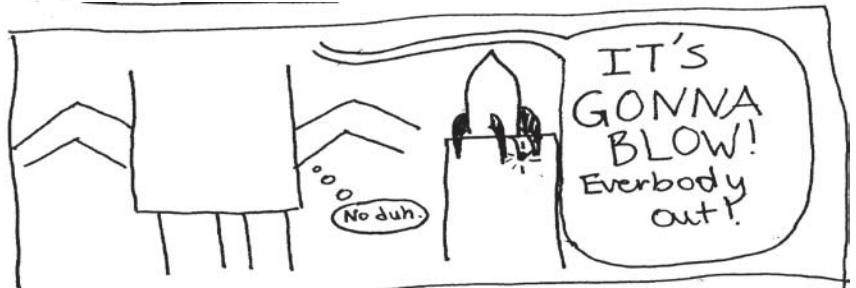
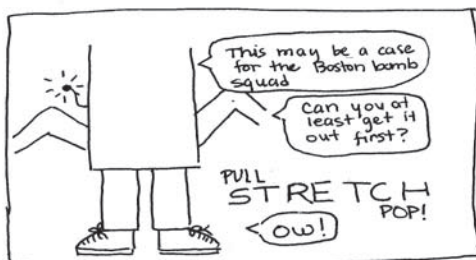
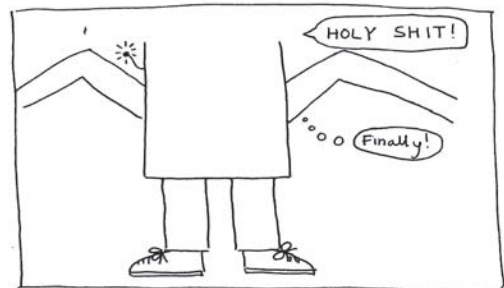
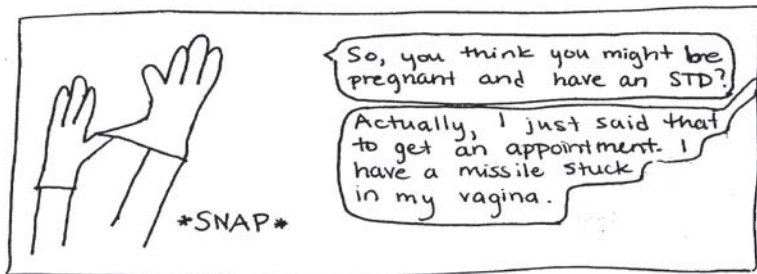
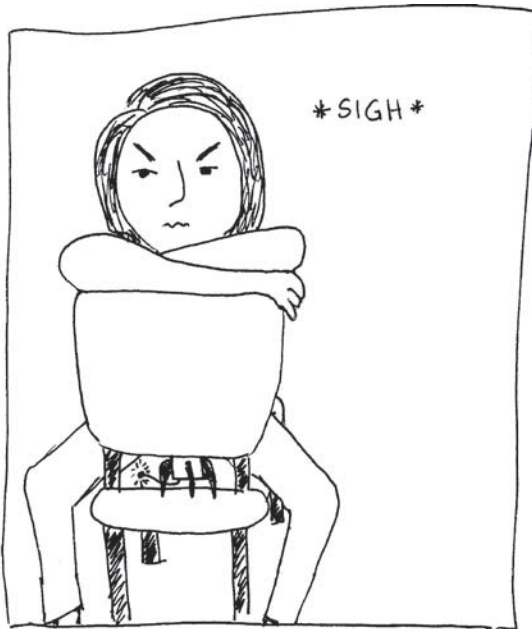

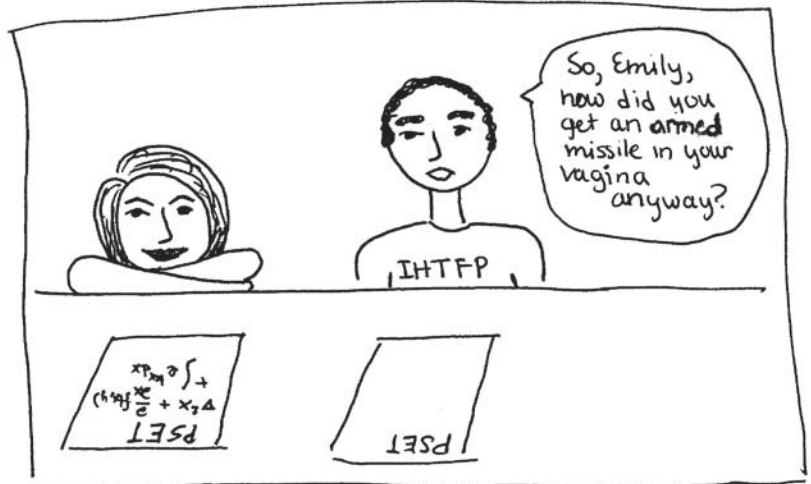
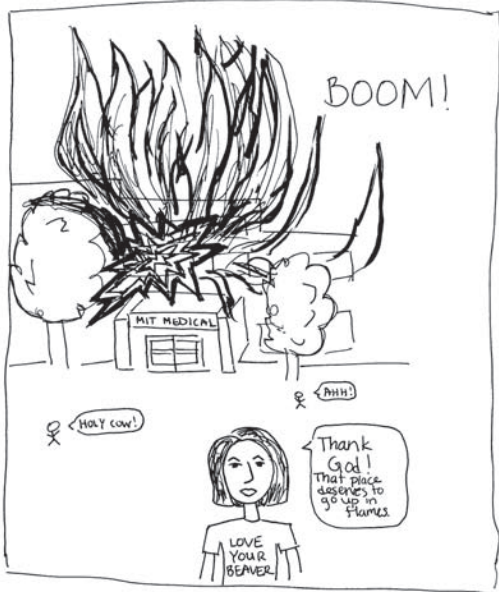
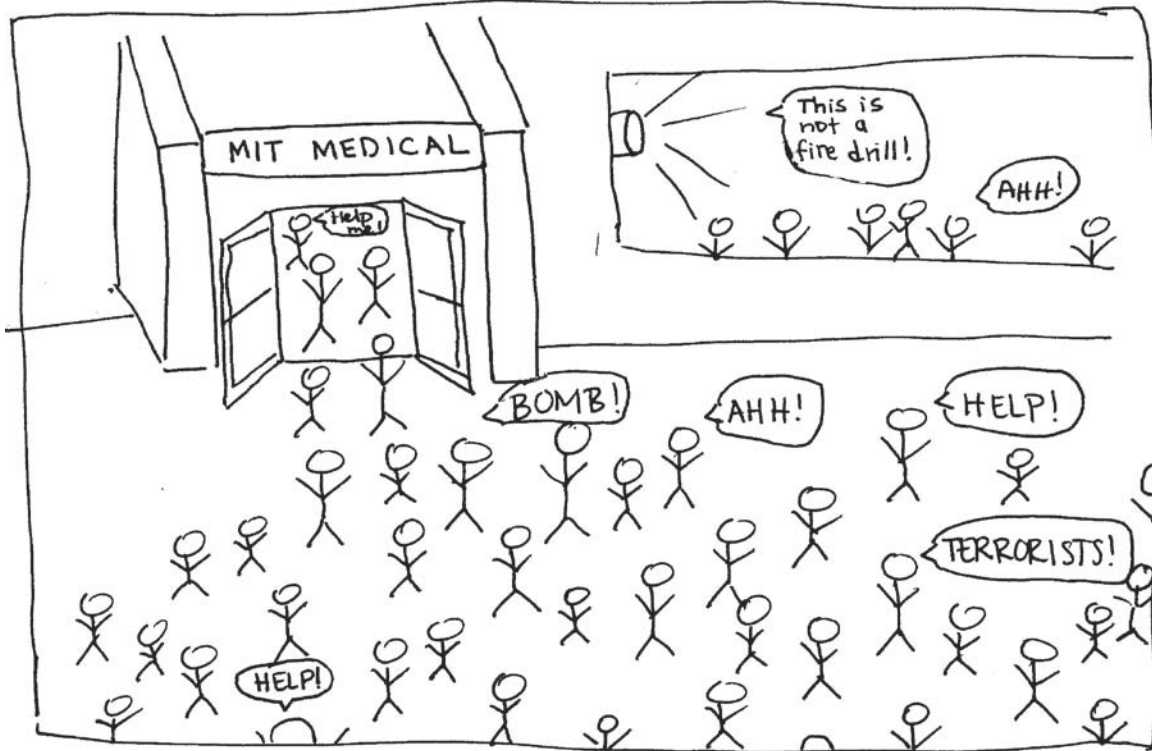

**SUBMIT TO
VOO DOO!**

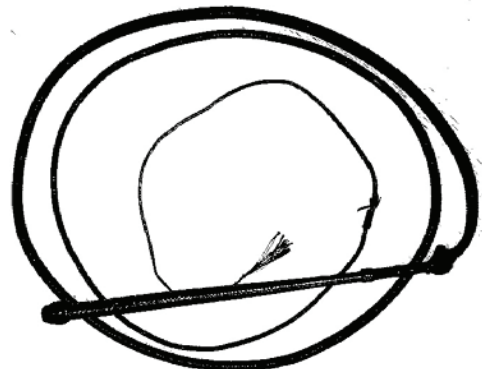

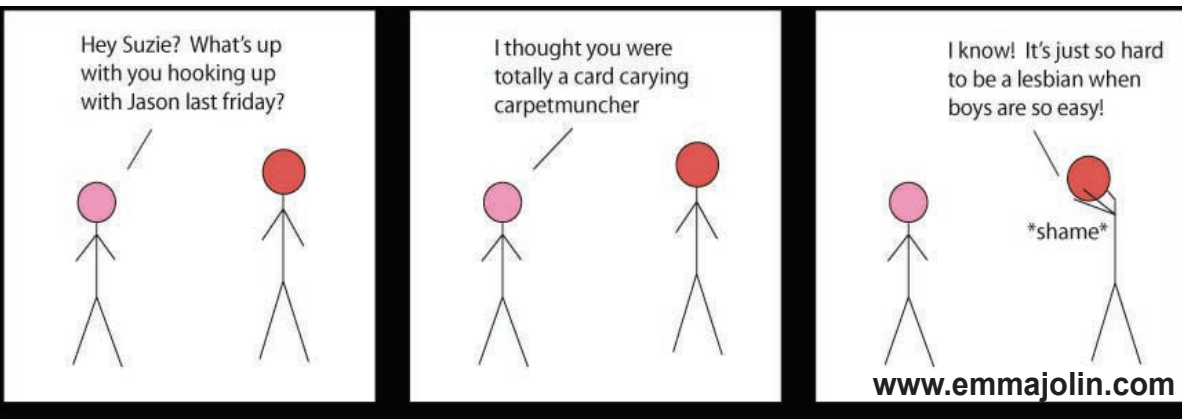
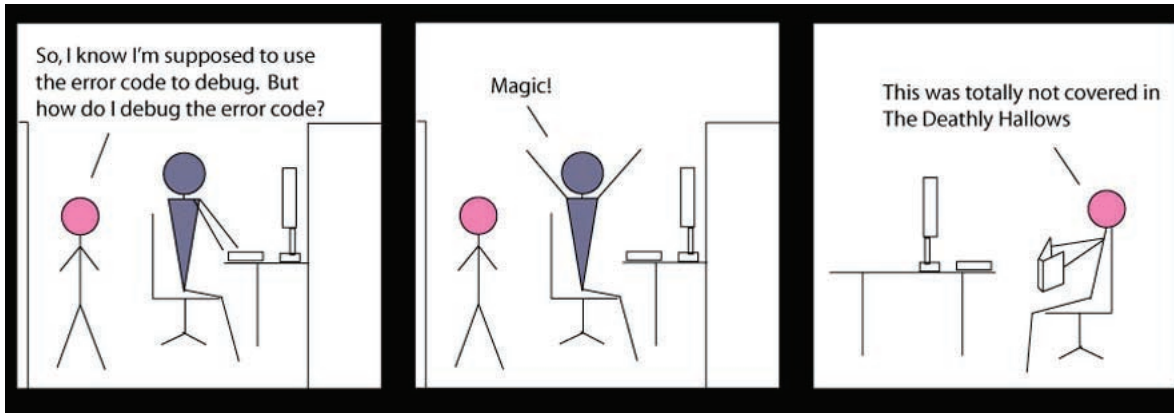
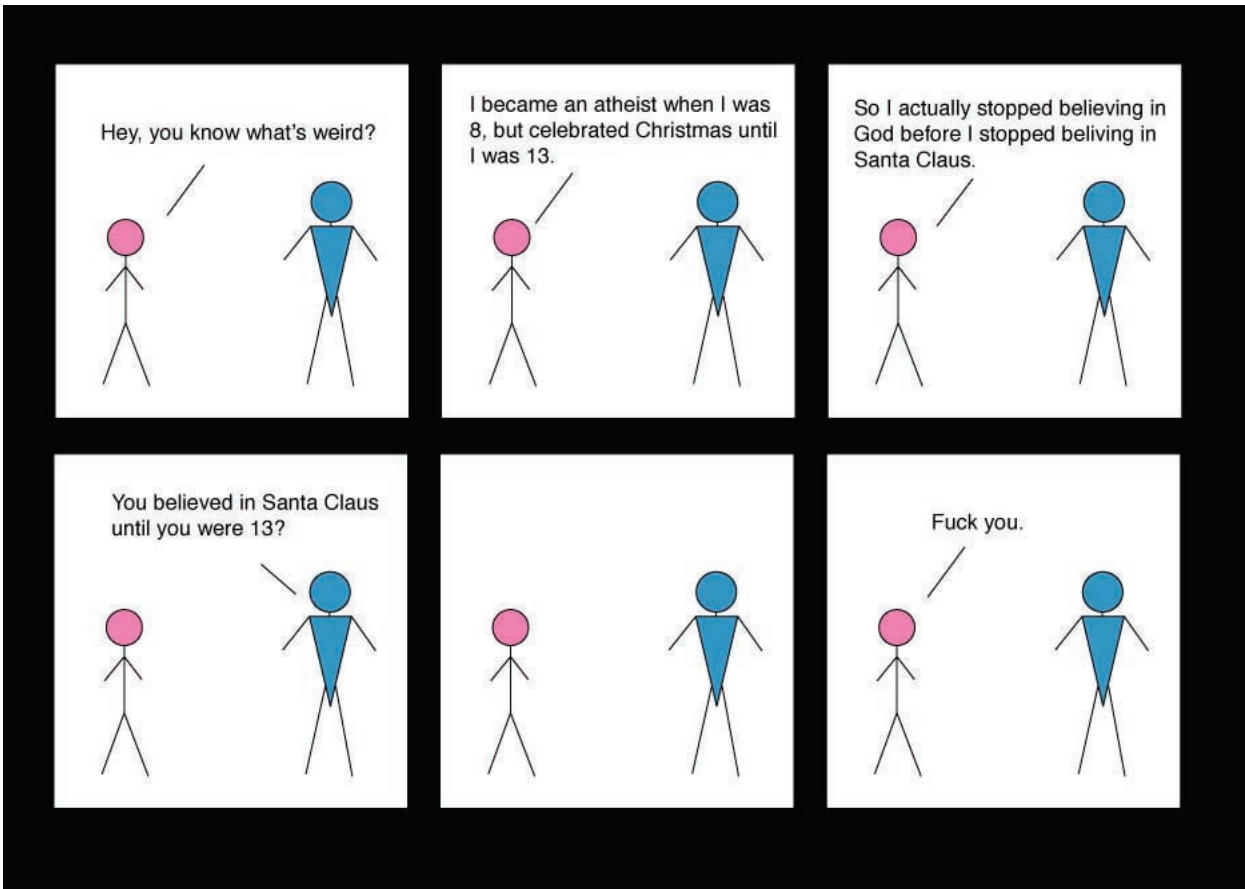

This picture in and of itself isn't funny. But that's okay! It's in color. Here's what we at Voo Doo imagine Ernie is saying: "Hi, I'm Ernie and I'm gay! There I've come out to you. And now that I've come out, I'm going to do a whole bunch of stereotypical gay boy things. Like spike my hair with gel. Aren't I like 1000 times sexier? Wow! I like Barbara Streisand. Now I can have a whole bunch of sex with ugly 50 year old gay guys at clubs and feel good about myself because I'm getting laid, unlike all you west campus suckers at MIT. Hahah!"

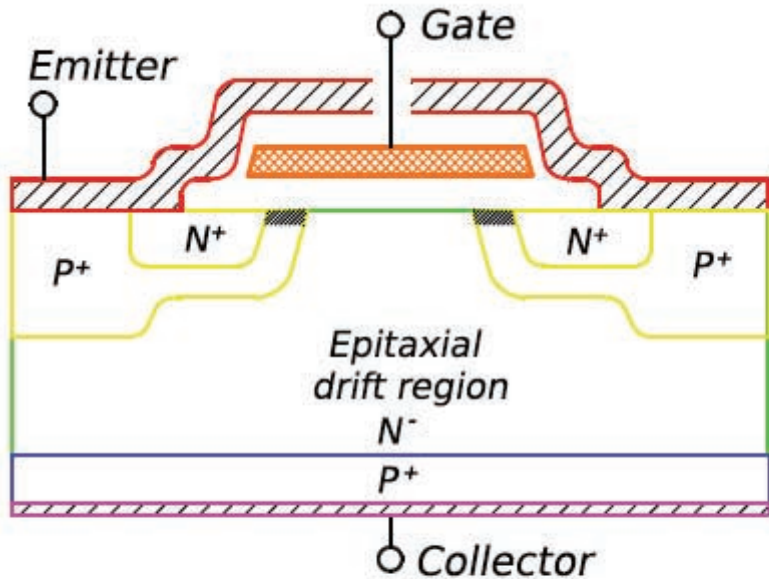

**you are
welcome
here**

igbt@MIT

<http://wikipedia.org/wiki/IGBT>

For all you course 6 nerds out there: we haven't forgotten about you. Everyone loves transistor humor. Or at least I love transistor humor. So laugh, dammit, laugh!

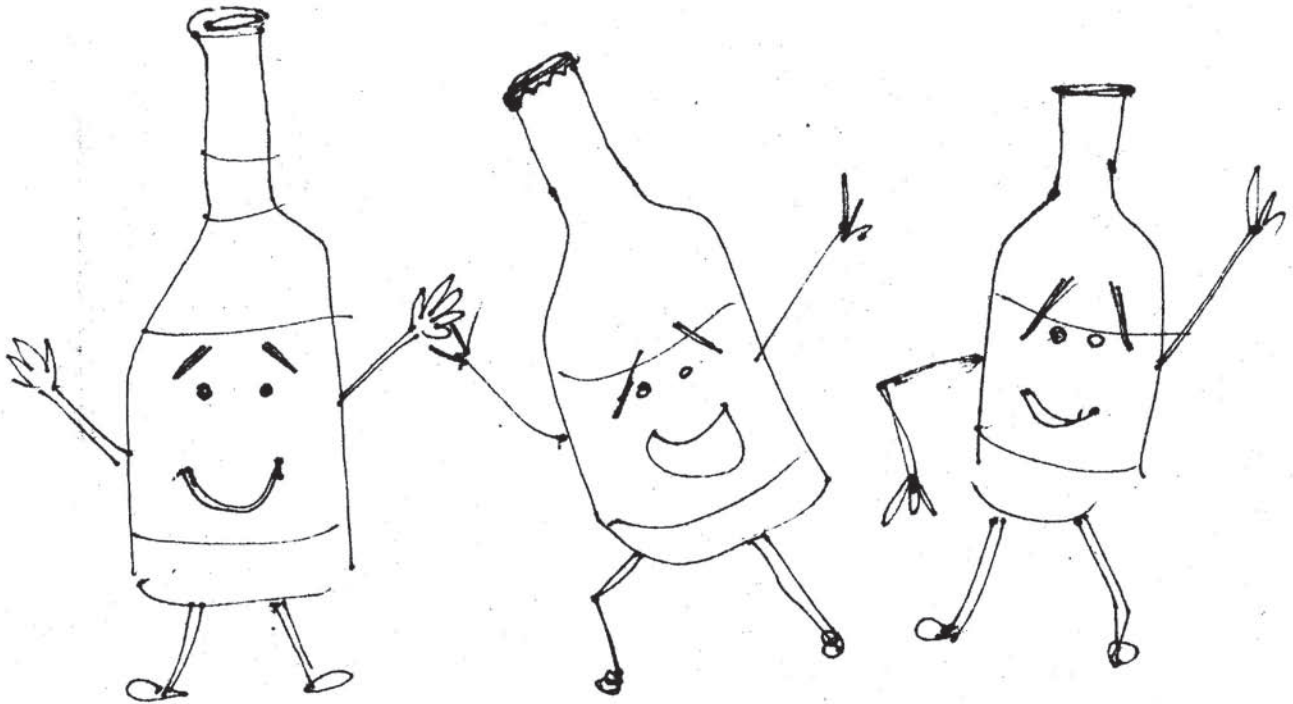

BEER LIKES YOU WHEN NO ONE ELSE DOES

THIS MESSAGE IS BROUGHT TO YOU BY THE OFFICE OF STUDENT MEDIATION AND COMMUNITY STANDARDS

Saturday Night

Ever wonder what makes a woman tick? Here at Voo Doo, we've figured it out. We recommend lubing up daily with WD-40.

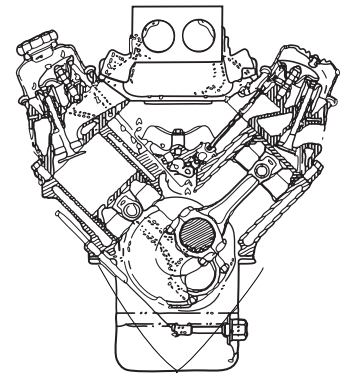

Look at the picture. No, don't ask what's funny about it, just look at it again. God damn it, look at the fucking picture. Okay, I give up, the fucking dog is masturbating. See the hands down the pants? He's not reaching for that last quarter. He's counting his pubic hairs, real slow. The addition of the "Saturday Night" title gives this its humor, mostly because that's what I'm doing right now.

Shitty Twos

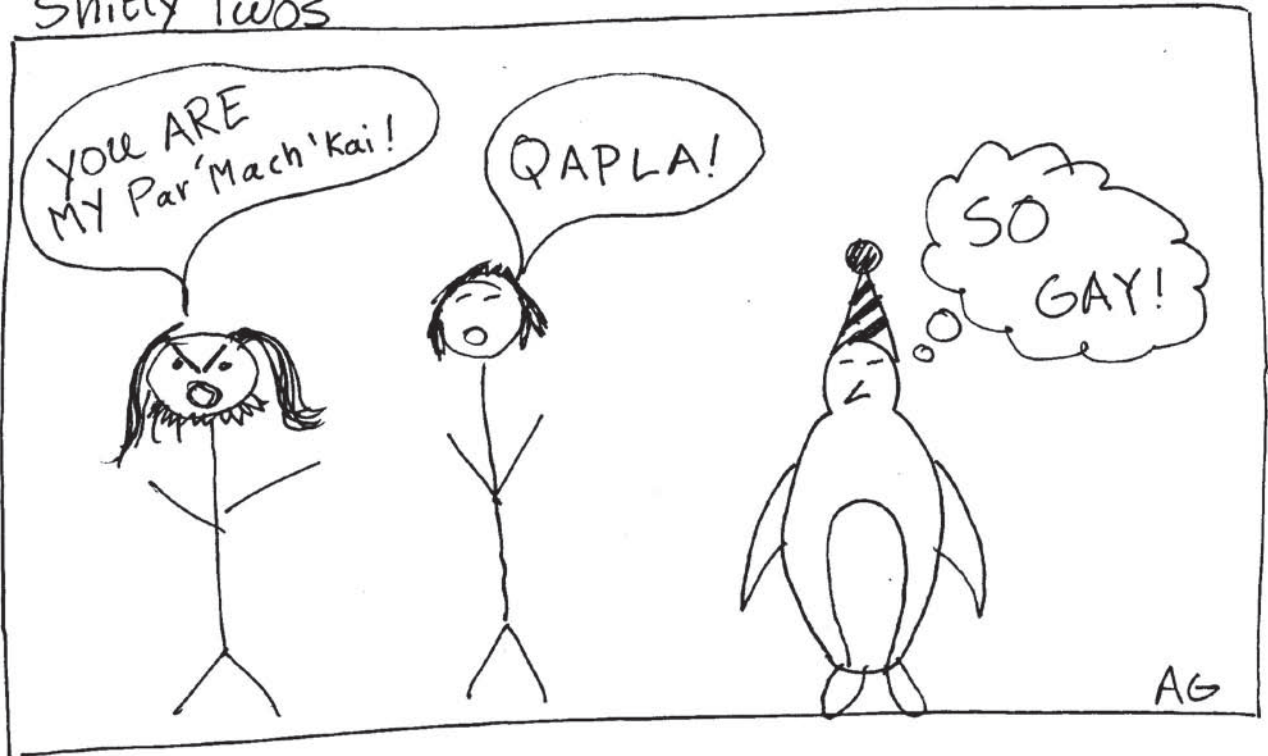

Star Trek jokes are so good, especially Klingon jokes. At least to me, this one is actually funny. Basically, the first guy is saying, "you're my soulmate," in Klingon. And the second guy is responding in Klingon, "oh yeah baby, let's fuck." I'm not really sure why the penguin is there or what could possibly be considered "gay" about Star Trek. Come on. This is offensive guys. Speaking of "gay," both of the people in this strip are guys, I think. Maybe these boys will get it on gay-Star Trek style. Hott. Sizzle. Sizzle. However, this joke was probably entirely lost on you since you are probably less of a loser than I am and don't spend at least 5 hours a day doing something Star Trek related. Like watching Star Trek, or reading Star Trek novels, or listening to the Star Trek sound track, or playing Star Trek role playing games, or masturbating to fan fiction where Wesley gets it on with Captin Picard (okay, maybe Star Trek is a little "gay"). You know what's better than Star Trek jokes? Star Trek + shit jokes. Klingons around Uranus. The captain's log is in the enterprise toilet. Haha. So funny.

Shitty Twos

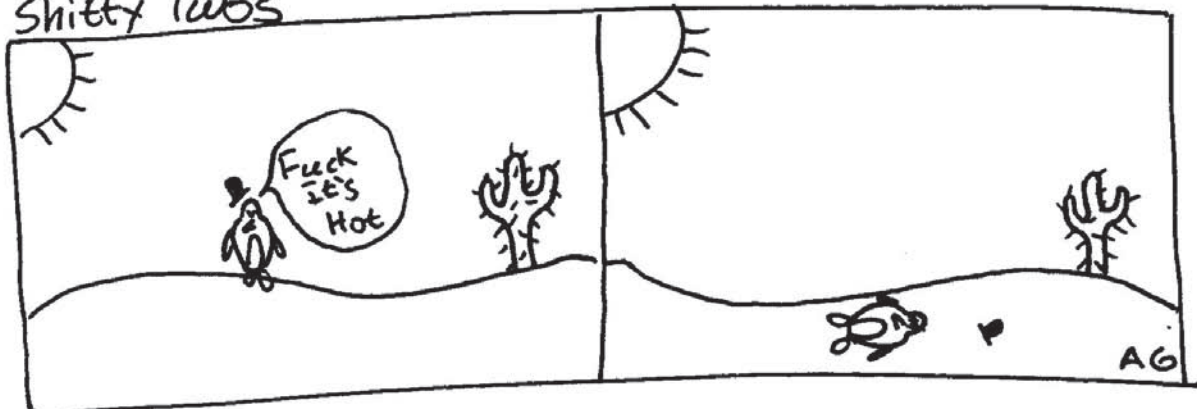

Here's another comic by the same guy. I think it's pretty shitty. But hey, it fills space. Man, more penguins. This guy must have a penguin fetish. Maybe he has a combined penguin Star Trek fetish where he often imagines Worf having anal sex with penguins while speaking in Klingon. Damn that would be hot.



JOIN REUSE-SEX!

athena% blanche -a username reuse-sex



Seriously, reuse-sex@mit.edu actually exists, and sometimes someone actually tries to get sex via it. The worst part is, even when two attractive women answer his post, he gets cold feet and limp-dick's out. Its a good reminder that the reason you're not getting laid is not because no one wants to fuck you, its because you have unreal expectations of beauty. So sign up today, its not like your sex life isn't already a public joke. v1agRa, she will love u!

SUBMIT TO VOO DOO!

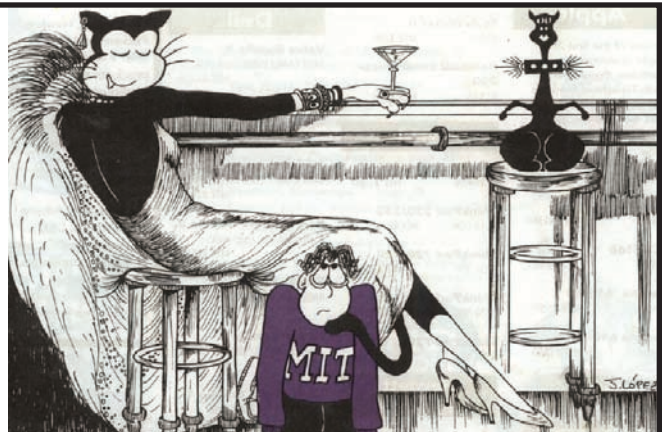

Voo Doo HUMOR CONTEST!

Photocopy this page, fill in the text bubbles, and send to voodoo@mit.edu.
The funniest submission will be published in the next issue of Voo Doo.

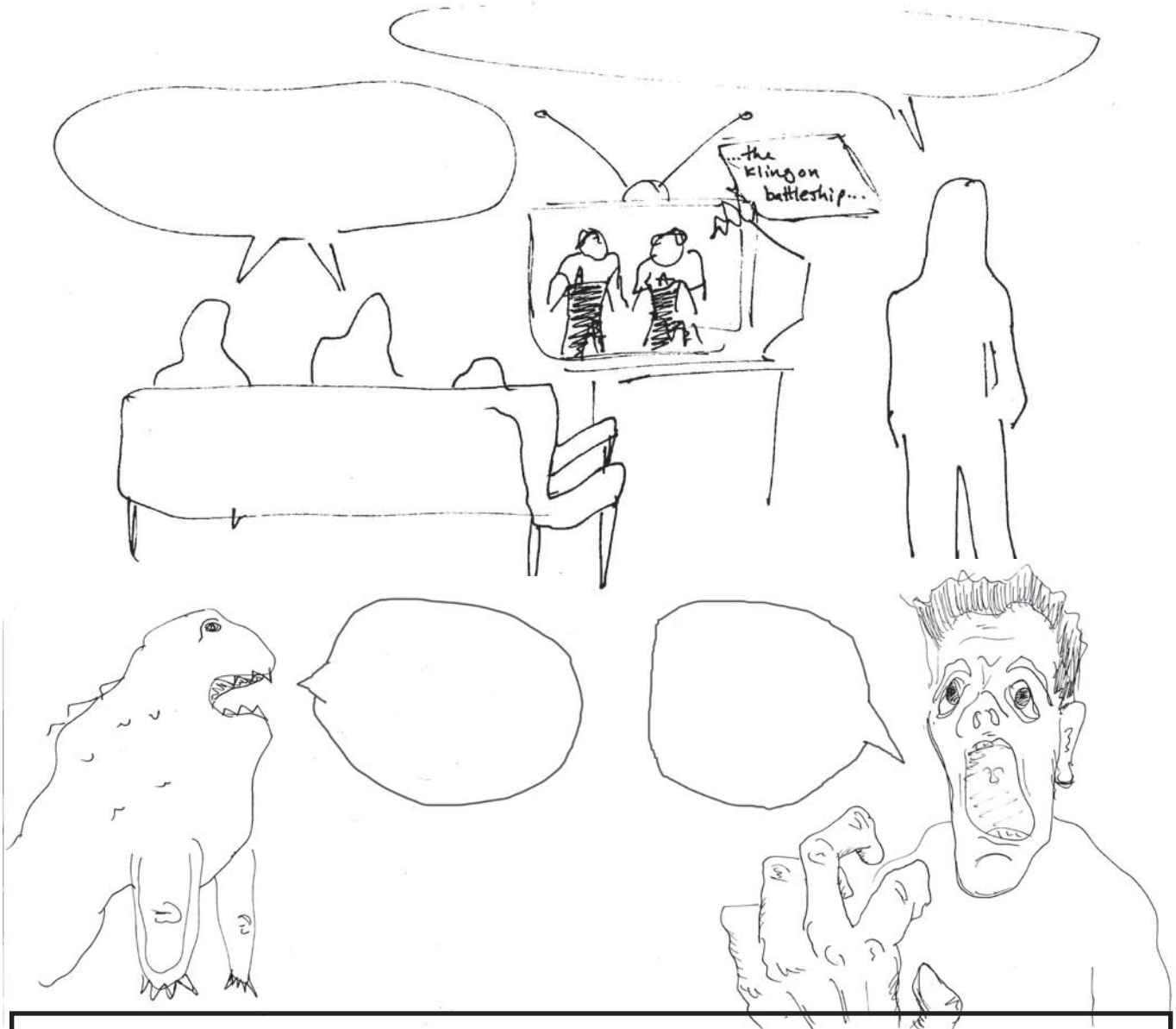

Welcome to the Voo Doo Humor Contest! Win valuable prizes! Rot valuable brain cells! Answer this quick question, and you're on your way to a humor goldmine: what do you do when you have a page to fill, and only a bunch of poorly drawn images to fill it with? Answer: you have a humor contest! Make those lazy readers come up with their own damn funny shit. Why should we do all the work? So here's how it works. You, kind reader, will fill in the word bubbles with things you find funny (quite frankly, any non-sequitor will do), and then you will send these back to us in 50-309. Interdepartmental mail will do the kind delivery service for you, and we will promise you fabulous fame and prizes. You will be the Britney Spears of the campus. In all actuality we will give you nothing, unless your stuff was funny, in which case we will give you the responsibility of making the next issue. So sharpen those pencils!

HOW MIT ADMINISTRATORS MAKE DECISIONS-

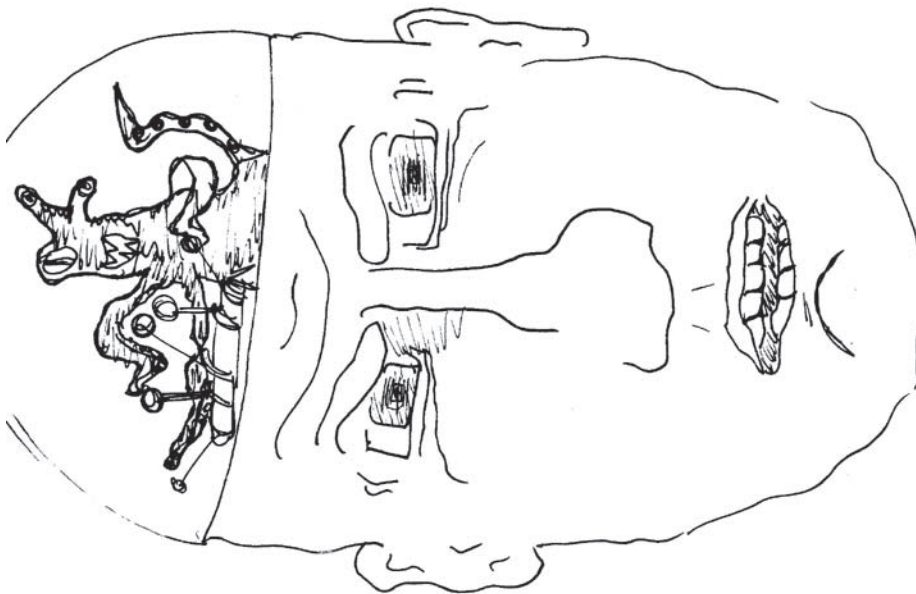

We at Voo Doo can't tell why the admins make some of the decisions that they do. The only plausible conclusion that we could come to is that admins have gremlins running their brains. This theory has the potential to explain a lot about their recent erratic behavior.

Andrew

<p>Welcome, Fresh, to 29.001. Today we are going about communication between fellow hackers.</p>	<p>Communication allows you to take an idea, over-analyze it and argue about it for hours only to come to the same conclusion as before.</p>	<p>This is essential in becoming a true MIT Hacker. Two profs will now demonstrate.</p>
<p>WANK WANK WANK WANK WANK WANK WANK WANK WANK WANK</p>	<p>Now you try.</p> <p>*Suggest *reconsider *agree*</p> <p>*Idea*</p>	<p>No. You Fucking Freshmen! Your being too... Civil Assert your Superiority!</p>
	<p>WANK</p>	<p>Excellent</p>



So here is a fine example of a Voo Doo self advertisement. It has the aim of getting more students to submit to the magazine, but since we all know that isn't going to happen, we also try to make it funny, so we can pass it off as another page of comics. The "Submit to Voo Doo" tagline is usually used in a BDSM context, because we all know sex sells, but in this case, we've done something different. We have combined two jokes in one. First, we are making a "your mom" joke, which is very popular with the kids these days. Secondly, we are making an internet meme joke. "The shocker" is one of those entertaining party tricks, like the "donkey punch," where you place two fingers in the person's vagina, and one in her anus. So in the end, we are making a pun as well. You see how simple this is, now why don't you go home and practice. The next submission deadline will be in April.

SUBMIT TO VOO DOO!
SHOCKING YOUR MOM SINCE 1919.



BEFORE THEY KILL YOU

Trees: they're nice and friendly. You like to sit under them on a summer's day. Oh wait! Not on the MIT campus! Their rotten branches will fall on you and nearly kill you. Plus this picture is in color! It's the back cover and we have to pick something that's in color, or else we're not getting our money's worth. That's probably the same reason you're taking too many classes and want to kill yourself. Hopefully, the poorly trimmed trees on the MIT campus can just take care of that for you so you don't have to bother with lighting yourself on fire or jumping off the green building. The more branches you cut off the fewer that can fall on you or you can hang yourself from.

THIS MESSAGE IS BROUGHT TO YOU BY THE MIT ARBORISTS.

HELP US MAKE THE CAMPUS SAFER BY DOING OUR JOB FOR US.

