

OMAE2006-9240

FATIGUE DAMAGE FROM HIGH MODE NUMBER VORTEX-INDUCED VIBRATION

Prof. J. Kim Vandiver

Department of Mechanical Engineering
Massachusetts Institute of Technology

Vivek Jaiswal

Department of Mechanical Engineering
Massachusetts Institute of Technology

Susan B. Swithenbank

Department of Mechanical Engineering
Massachusetts Institute of Technology

Vikas Jhingran

Department of Mechanical Engineering
Massachusetts Institute of Technology

ABSTRACT

This paper presents results from two field experiments using long flexible cylinders, suspended vertically from surface vessels. The experiments were designed to investigate vortex-induced vibration (VIV) at higher than tenth mode in uniform and sheared flows. The results of both experiments revealed significant vibration energy at the expected Strouhal frequency (referred to in this paper as the fundamental frequency) and also at two and three times the Strouhal frequency. Although higher harmonics have been reported before, this was the first time that the contribution to fatigue damage, resulting from the third harmonic, could be estimated with some certainty. This was enabled by the direct measurement of closely spaced strain gauges in one of the experiments.

In some circumstances the largest RMS stress and fatigue damage due to VIV are caused by these higher harmonics. The total fatigue damage rate including the third harmonic is shown to be up to forty times greater than the damage rate due to the vibration at the fundamental vortex-shedding frequency alone. This dramatic increase in damage rate due to the third harmonic appears to be associated with a narrow range of reduced velocities in regions of the pipe associated with significant flow-induced excitation.

INTRODUCTION

Higher harmonic VIV response has been discussed in the offshore engineering literature for over twenty five years. In-line vibration at twice the cross-flow vibration frequency is common knowledge and has been associated with figure eight motions since the early 1980s [1, 2]. The third and fifth harmonics were noticed in accelerometer measurements described in the late 1980's [3], but were not considered to be of significant concern when making fatigue life estimates.

This was because the response at the frequency of the third and fifth harmonics was quite small in these early experiments on flexible cylinders in uniform and sheared flows.

The measured strains at the third harmonic in the experiments described in this paper are not small or negligible. The early experiments involved cylinders at similar Reynolds numbers, mass ratios, and damping. The key difference between the experiments conducted twenty to twenty five years ago and the experiments described in this paper is the excited mode number. The principal responding cross-flow vibration mode in the 1980's experiments was second, third or perhaps fourth mode. In the recent experiments the twentieth to thirtieth modes responded at the fundamental VIV frequency.

In the early experiments, the low mode number and low modal density did not favor the occurrence of resonance between the third harmonic of the lift force and a pipe natural frequency. In the recent experiments, the third harmonic corresponds to approximately the 60th modal natural frequency. Adjacent natural frequencies are very close together and significant response is always possible. A frequency shift of less than 2% moves the mode number from fifty-ninth to the sixtieth.

EXPERIMENT DESCRIPTION

Two experiments were conducted. The first experiment was carried out at a US Navy test facility on Lake Seneca in upstate New York in the summer of 2004. The Lake Seneca tests focused on the effect of VIV at high mode numbers for a pipe in uniform flow. The second experiment was conducted in the Gulf Stream near Miami. The Gulf Stream tests, conducted in the fall of 2004, focused on a long pipe in sheared flow. Both tests were part of a testing program

developed with DEEPSTAR, a joint industry technology development project.

The goals of the overall test program were to understand the dynamics of a pipe undergoing VIV at high mode number. This included VIV suppression with strakes, drag coefficients of bare and straked pipes, in-line and cross-flow VIV, and damping factors. This paper discusses the higher harmonic frequencies observed in the dynamic response of the pipe.

Lake Seneca Experiment

The Lake Seneca test facility was selected because it was a fully equipped field test station moored in calm, deep water. It was ideal for conducting a controlled test on a long circular pipe in uniform flow. This was accomplished by towing a nearly vertical, composite pipe with a suspended bottom weight to produce the desired tension.

The 1.31 inch diameter fiberglass composite pipe was manufactured by Fiberspar, Inc. in Marion, Massachusetts. The pipe was cut into one hundred foot lengths to enable cables and accelerometers to be placed inside. In the field the 100 foot sections were joined together to complete a pipe 401 feet in total length. Other pipe properties, in English and SI units, can be found in Table 1. Each 100 foot long section of pipe contained six almost evenly spaced tri-axial accelerometers. These accelerometers were sampled by analog to digital converters and micro-processors located locally at each accelerometer unit. The sampling rate used in these experiments was 60 Hz for all the accelerometers. The pipe was filled with a flexible epoxy compound to exclude water, hold the wires in place, and maintain the orientation of the accelerometers relative to the pipe.

The length, diameter, tension of the pipe, and boat speed were chosen so as to permit cross-flow excitation of up to the twenty-fifth mode. The maximum speed possible with the system at Lake Seneca was limited by the maximum allowable deflection angle of the pipe. Typical towing speeds ranged from 1.0 to 3.5 ft/s, (0.3 to 1.1m/s). Reference [4], provides an analysis of the design tradeoffs when attempting to achieve high mode number. This was done in terms of tension, length, diameter, and top angle.

Table 1 - Lake Seneca Pipe Properties

Outer Diameter	1.310 in.(0.0333m)
Inner Diameter	0.980 in (0.0249m)
Lengths tested	201 & 401 feet(61.26 & 122.23m)
Effective tension	725 lbs submg. bottom weight (3225N)
Modulus of Elasticity (E)	1805.0 ksi (1.276E10 N/sq m)
Moment of Inertia (I)	3.994E-06 ft ⁴ (3.447E-8 m ⁴)
EI	149489.3 [lb-in ²](429.0 N-m ²)
Mass / Displaced Mass of water	1.35
Weight in air	0.79 [lb/ft](11.53 N/m),(1.176 kg/m)
Manufactured by	FiberSpar

At Lake Seneca, the current profiles seen were essentially uniform, with the current over the pipe being equal to the speed of the boat. The mean curvature of the pipe near the top

end did change the normal incident velocity component on the pipe. However, as the top angles of the pipe were less than 30 degrees from vertical the normal component of the current near the top was not diminished by more than 15%. Most of the pipe experienced the full speed of the current normal to the axis of the pipe. At the top of the pipe a load cell and tilt meter were attached to allow the measurement of the tension in the pipe and the top angle of inclination.

Towing speed was measured by two mechanical current meters. One was suspended underneath the towed weight and the other was hung over the side of the towing vessel.

A railroad wheel was connected to the bottom end to provide tension. Fins mounted on the railroad wheel prevented significant pitch, roll and torsional rotation. The towed weight was designed such that the dynamic response characteristics of the railroad wheel would not interfere with the desired VIV response. In particular the pitch and roll natural frequencies of the weight were approximately 0.68 Hz, which was significantly lower than the lowest VIV response frequency of interest. The Experimental set-up is shown in Figure 1.

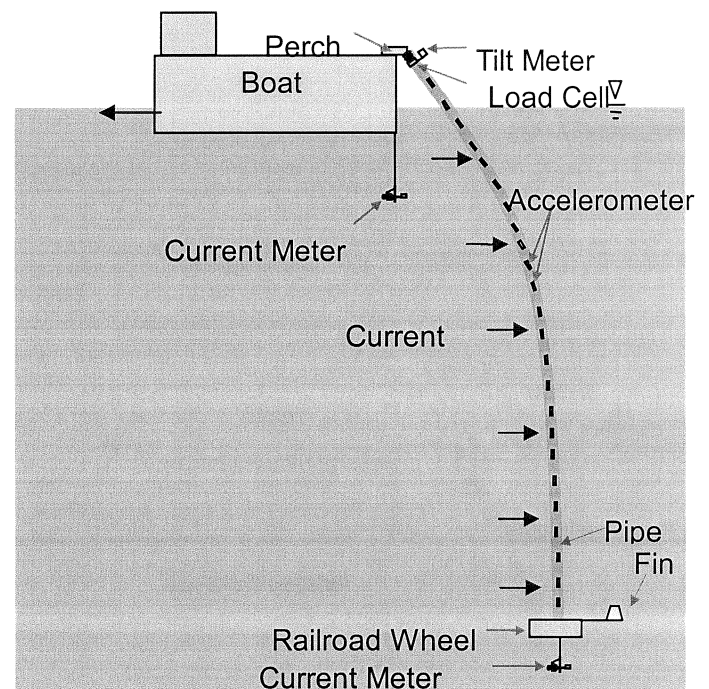

Figure 1 - Experimental Setup

Gulf Stream Experiment

The Gulf Stream tests were conducted on the Research Vessel F. G. Walton Smith from the University of Miami using a carbon fiber composite pipe 484 feet long and 1.4 inches in diameter. The pipe was spooled on a drum that was mounted on the aft portion of the ship. The pipe was lowered directly from the drum into the water. A railroad wheel weighing 805 lbs (dry weight, 725 lbs in water), was attached to the bottom

of the pipe to provide tension, as was done in the Lake Seneca experiment.

The top end of the pipe was attached to the stern of the boat on a perch. The boat steered on various headings relative to the Gulf Stream so as to produce a large variety of sheared currents, varying from nearly uniform to highly sheared in speed and direction. Eight optical fibers were embedded in the outer layers of the composite pipe. Each fiber contained thirty five strain gauges, which use the principle of Bragg diffraction to measure strain with a resolution of approximately 1 micro-strain. Two fibers were located in each of the four quadrants of the pipe, as seen in Figure 2.

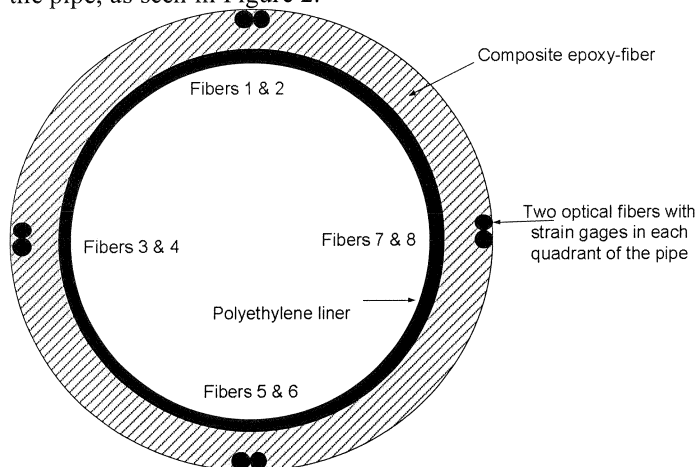

Figure 2 - Cross-Section of the Pipe from the Gulf Stream Test

Each fiber had a strain gauge spacing of fourteen feet. Each quadrant pair of fibers was positioned so that the strain gauges in one fiber were offset from the gauges in the other fiber by seven feet, as shown in Figure 3. The fiber optic strain gauge system was provided by Insensys, Ltd. in the UK. The fibers were embedded in the pipe during manufacture by Hydril, Inc. at their fabrication facility in Houston.

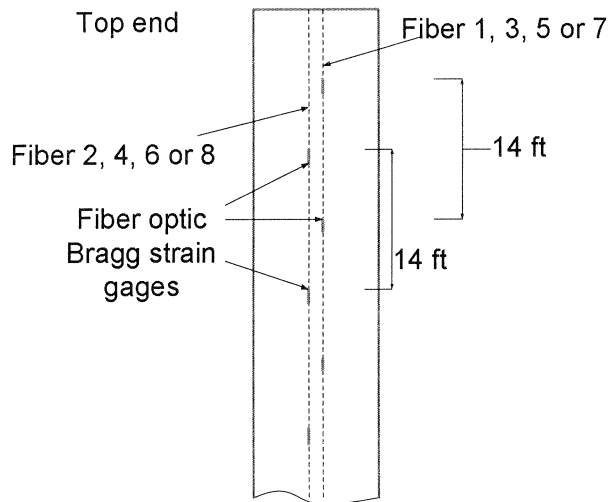

Figure 3 - Side View of the Pipe from the Gulf Stream Test

The pipe was made of a carbon fiber composite with an HDPE liner. The pipe properties are found in Table 2.

Table 2 –Gulf Stream Pipe Properties

Inner Diameter	1.05 in. (0.0267 m)
Outer Diameter	1.40 in.(0.0356 m)
Optical Fiber Position	1.30 in.(0.033 m)
EI	1.7e5 lb.in ² (488 Nm ³)
Modulus of Elasticity (E)	2.30e6 lb./in ² (1.586e10 N/m ²)
EA	8.5e5 lb. (3.78e6 N)
Weight in Seawater	0.12 lb./ft. (flooded in Seawater) (1.75 N/m)
Weight in air, w/trapped water	0.83 lb./ft. (12.11 N/m)
Density	0.053 lb/in ³ (1.47 g./cc).
Effective Tension	725 lbs submg. bottom weight (3225N)
Material	Carbon fiber –epoxy
Length	485.3 ft (147.3 m) (U-joint to U-joint)
Manufactured by	Hydril (now Futurepipe)

An Acoustic Doppler Current profiler (ADCP) recorded the current velocity and direction along the length of the pipe. On the R/V F. G. Walton Smith, there are two ADCPs. Each ADCP uses a different frequency to obtain different currents at different depths. The broadband (600 kHz) ADCP records the current at greater resolution and accuracy at the shallow depths, whereas the narrowband (150 kHz) ADCP records the current at deeper depths. During the Gulf Stream testing both ADCPs were used to gather data.

Additional instrumentation included a tilt meter to measure the inclination at the top of the pipe, a load cell to measure the tension at the top of the pipe, and two mechanical current meters to measure current at the top and the bottom of the pipe.

Significant wave induced vessel motion during the Gulf Stream test caused significant tension variations and added low frequency components to the strain time series. An elliptical filter with a 1.5 Hz cut-off was used to remove this vessel motion from the data without interfering with the VIV frequencies. The filtering was done such that no phase shift was applied to the data. Tension fluctuations due to vessel motion varied from 10% to 25% of the mean.

EXISTENCE OF HIGHER HARMONICS

Many VIV experiments by Vandiver, dating back to the 1980's, reported that vibrations associated with the fundamental VIV frequency are often accompanied by vibrations at integer multiples of this frequency [3]. Of these, the odd multiples are associated with the cross-flow direction and the even multiples correspond to the in-line direction. This paper studies the odd harmonics and mainly considers the vibrations at three times the fundamental VIV frequency; this is referred to in this paper as the 3x frequency.

For this paper, one example from the Lake Seneca test (0407141542) and one example for the Gulf Stream test (20041029164735) will be used to illustrate the existence of

these higher harmonics and their effect on the RMS response and the fatigue damage rate of the pipes.

Observations from Lake Seneca

As stated above, the current profiles at Lake Seneca were essentially uniform with the only variation caused by the angle of the pipe with the vertical. Figure 4 shows the cross-flow acceleration Power Spectral Density (PSD) for a Lake Seneca test. The normal incident current on the pipe varies from 1.76 ft/s (0.54 m/s) at the top to 2.0 ft/s (0.61 m/s) at the bottom. The angle that the pipe makes with the vertical was highest near the top; therefore most of the variation in normal incident current velocity occurs near the top, and remains constant below 150 ft ($x/L = 0.37$). The PSDs in the figure correspond to points located at 75 ft ($x/L = 0.19$) and 309 ft ($x/L = 0.77$) from the top end. The odd harmonics were seen in the cross-flow spectrum while the in-line spectrum captures the even harmonics. As mentioned earlier, this paper focuses on the cross-flow components and therefore the odd harmonics.

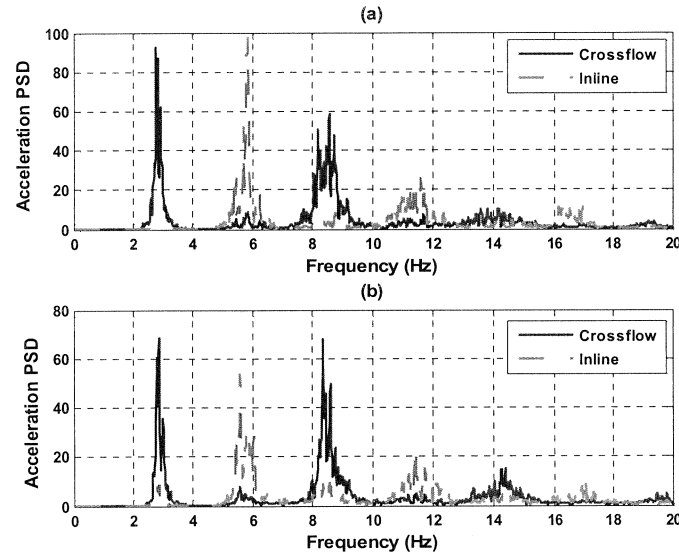

Figure 4 – Cross-flow and in-line acceleration PSDs showing the lack of spatial variation in frequency content in the Lake Seneca experiments. $1.76 \text{ ft/s} < U_n < 2.0 \text{ ft/s}$ and $5.5 < V_r < 6.6$ (a) $x/L = 0.19$ from top end (b) $x/L = 0.77$ from top end. The units of both (a) and (b) are $(\text{m/s}^2)^2/\text{Hz}$

The PSD of the acceleration response at Lake Seneca shows that the frequency content was sharply peaked, indicating that the excitation was quite narrow band at the fundamental excitation frequency. Although the magnitudes of the PSDs at the two different locations were different, the frequency content was the same at both points, indicating that the same fundamental VIV frequency was excited along the whole length of the pipe. Figure 4 also shows that there was significant energy in the cross-flow spectrum at the 3x frequency.

The reduced velocity, V_r , seen for this example at Lake Seneca varied from 5.5 to 6.6; where V_r is defined as:

$$V_r = \frac{U_n}{f_v * D_o} \quad (1.1)$$

U_n is the normal incident current speed which takes into account the angle of the pipe with the vertical, f_v is the measured fundamental frequency of vibration, and D_o is the outer diameter.

The blue circles in Figure 5 show the total Root Mean Square (RMS) acceleration due to the fundamental response peak and the higher harmonics in the cross-flow direction. The red squares represent the RMS acceleration response associated with the fundamental response peak only. The higher harmonic content was removed by filtering the time series prior to computing the RMS value. The RMS contributions of the fundamental frequency were approximately fifty percent of the total RMS acceleration in this case.

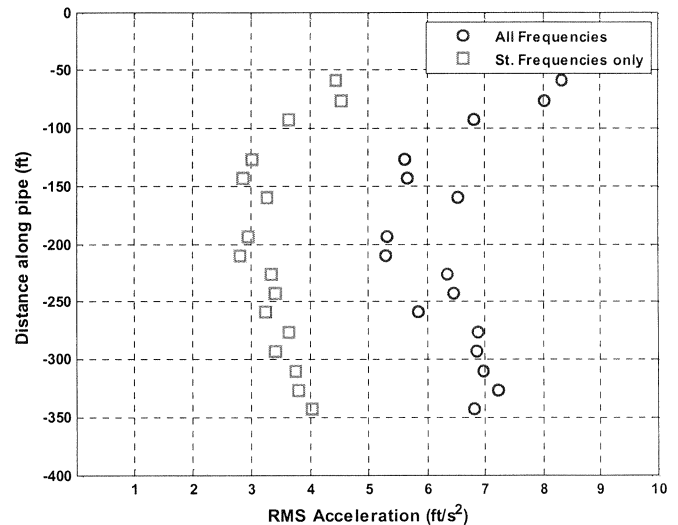

Figure 5 – Total cross-flow RMS acceleration and RMS of the component due to the fundamental frequency for the Lake Seneca test. $1.76 \text{ ft/s} < U_n < 2.0 \text{ ft/s}$

The acceleration time histories from the Lake Seneca experiment were used to calculate fatigue damage to the pipe, using the rainflow cycle counting method. The analysis in this paper uses the Wave Analysis for Fatigue and Oceanography (WAF0) [6] MATLAB toolbox developed by Lund Institute of Technology in Sweden to perform rainflow cycle counting and to predict fatigue damage rate. For these predictions the pipe was assumed to be steel and have the same properties as the API X' SN curve ($A=2.5E13 \text{ MPa}$, $m=3.74$).

The Lake Seneca experiment recorded acceleration. Since fatigue damage calculations require stress measurement, the data was converted from acceleration to strain using a beam model that includes both the effects of tension and stiffness as

described in [7]. The transformation algorithm from acceleration to strain is linear. Thus a doubling in acceleration RMS leads to a doubling in RMS strain and stress. The fatigue calculation assumed that this pipe was made of steel with API X' SN properties and had the same dimensions as the Seneca Test pipe. The WAFO rainflow counting routine was used to calculate fatigue damage at each measurement location along the pipe.

The noise at frequencies well above the VIV frequencies did not contribute substantially to the RMS acceleration but introduced significant errors in the fatigue life calculations. For this reason, the signal was low pass filtered at eleven Hertz before calculating the total fatigue damage. Thus the third harmonic contribution to fatigue damage was included in the estimate but higher frequencies were excluded. Figure 6 shows the stress and fatigue damage rate results for this example from Lake Seneca.

Since the RMS acceleration shown in Figure 5 was approximately doubled by the inclusion of the third harmonic contribution, the expected damage rate would increase by a factor of at least 2^m which is approximately ten. This increase in damage is addressed later in this paper and shown to be true.

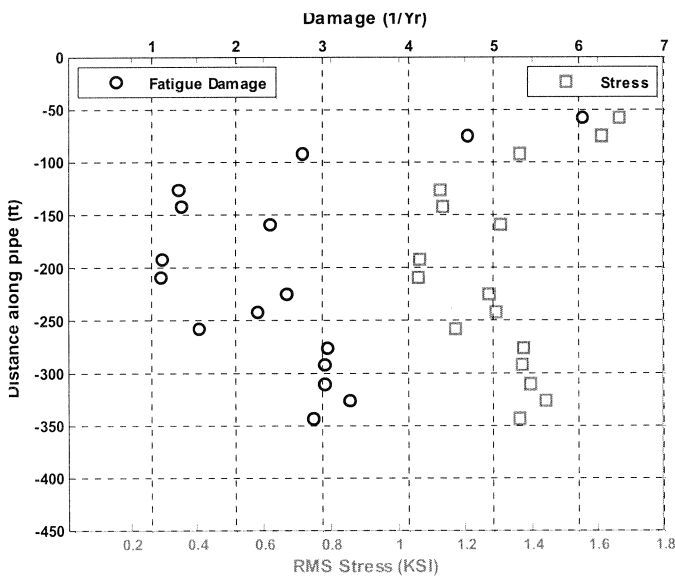

Figure 6 – Spatial distribution of RMS Stress due to cross-flow VIV and the resulting fatigue damage rate along the pipe for this example from the Lake Seneca Experiment.

Observations from the Gulf Stream

The currents in the Gulf Stream experiment were highly sheared and changed direction with depth. Moreover, orientation of the strain gauges changed with depth due to a 60° twist in the pipe induced during manufacturing. These factors made it generally impossible to know the orientation of the strain gauges with respect to the local in-line and cross-flow direction. For the pipe as a whole, there is no unique in-

line and cross-flow direction, because the locally-generated vibration from one point may propagate to a distant location on the pipe where the angle of incidence of the current is different. Occasionally, at a single location, the locally-generated current was much stronger than the vibration amplitude resulting from distant sources of excitation. At these locations, the frequency content shows distinct in-line and cross-flow response.

Figure 7 shows the current profile, the fundamental VIV frequency, and the reduced velocity versus depth for the example from the Gulf Stream. Figure 7 (a) shows the normal incident current profile. The angle of the pipe at each measurement location was predicted using the measured top tilt angle and a finite element analysis program. Figure 7 (b) shows the fundamental VIV frequency at each location. Figure 7 (c) is the reduced velocity calculated from the local normal incident current and the local fundamental VIV frequency.

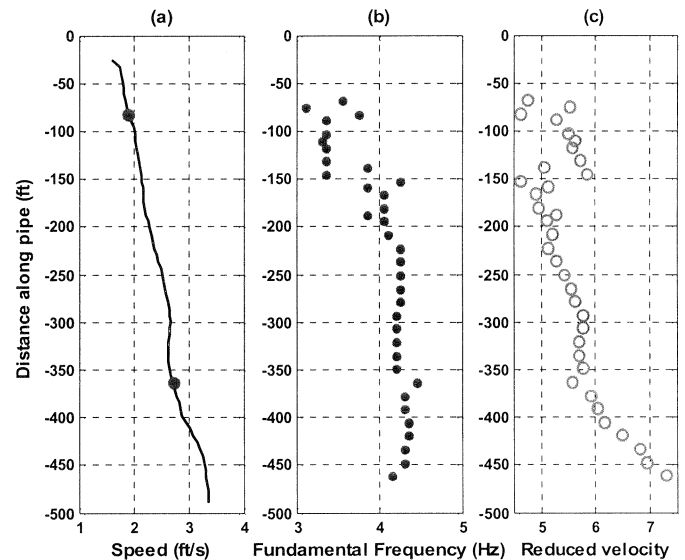

Figure 7 - (a) Normal incident current profile for the Gulf Stream Example with the locations of the two spectra shown in Figure 8; (b) The fundamental VIV frequency at every measurement location; (c) The reduced velocity associated with the local fundamental VIV frequency and the local normal incident current speed.

Figure 8 shows two strain PSDs at points separated by 280 ft (58% of the length) for the Gulf Stream test. Figure 8 (a) shows the spectra of two orthogonal gauges at 82 ft ($x/L = 0.17$) from the top of the pipe. Figure 8 (b) also shows the spectra from two orthogonal gauges at 363 ft ($x/L = 0.75$) from the top of the pipe. The solid blue curve in Figure 8 (b) appears to come from a gauge aligned with the local cross-flow direction because the PSD has peaks at the odd harmonics whereas the orthogonal strain gauge in the dotted red A_y/D_o shows the expected even harmonics. The current profile for this example is also shown in Figure 7 (a) with the dots showing the two measurement locations referred to in Figure 8.

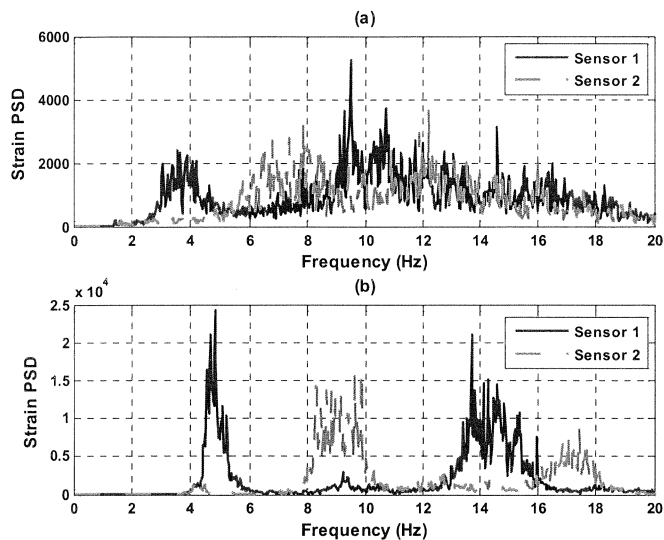

Figure 8 – Strain PSDs for two orthogonal directions in the Gulf Stream experiment (a) $x/L = 0.17$ from the top end is an area of low RMS response (b) $x/L = 0.75$ from the top end is an area of high RMS response. The units of both spectra are Pico-second.

The strain gauges spectra shown in Figure 8 (b) were from the region of the highest RMS response; see Figure 9. In this region, the frequency response was similar to that seen in the Lake Seneca frequency response. However, both the fundamental frequency and the higher harmonics were more broad-banded than the Lake Seneca experiment, but were still clearly identifiable.

The authors hypothesize that the region of maximum RMS strain is the principal region where vibration energy was entering the system, and is designated a “power-in” region. The frequency content in this region is primarily due to local VIV excitation. The cross-flow PSD in blue has distinct fundamental and third harmonics, whereas the in-line in red has significant second and fourth harmonic components.

Away from the region of high response, the PSD of strain becomes very broad-banded in nature. Regions of lower RMS strain, such as that seen in Figure 8 (a), do not appear to have distinct locally-generated dominant frequency peaks. Instead the frequency content appears to be a mixture of traveling waves coming from other “power-in” regions. This results in a large number of frequencies contributing to a broad-banded strain PSD.

In Figure 9, the RMS responses from all of the gauges on a single optical fiber are shown. Only at $x/L = 0.75$ do we assert that the orientation of the measurement shown in the plot is such that the strain gauge is aligned with the local cross-flow. The rest of the measurements vary due to gradual twist in the pipe and variations in the local current direction. Nonetheless, this is one of the best samples available for the response data over the full length of the pipe. Numerous breaks in the optical fibers covering the five days of the experiment limited the amount of measured data.

The RMS strain contributions associated with the fundamental frequency were separated from the total RMS strain contributions using a filtering technique similar to that used for the Lake Seneca Data. Figure 9 shows the RMS strain for the total signal as well as the RMS strain associated with the fundamental frequency. Except for the sensor at $x/L=0.75$, most of the sensors were not ideally oriented to capture the total contribution of the fundamental or third harmonics. Figure 9 should be interpreted as the total RMS response measured by the strain gauges in one quadrant only. Thus the conclusions based on the measured amplitudes are limited to being qualitative rather than precisely quantitative ones. Although the amplitude information is limited, the frequency of peaks is quite reliable in the high response regions.

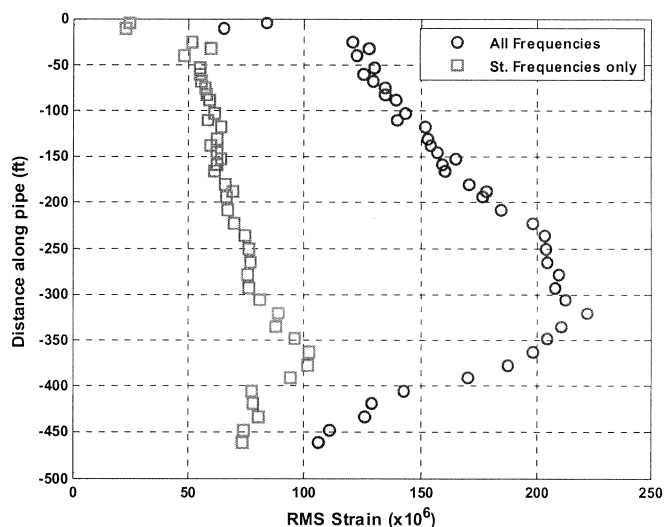

Figure 9 – RMS Strain from Gulf Stream test: blue circles are the total response, red squares represent only the fundamental frequency response.

The region of highest RMS strain including the fundamental and third harmonics spans the pipe from approximately 200 feet to 400 feet ($0.41 < x/L < 0.82$). In this region the reduced velocity varied from 5 to 6, Figure 7 (c).

Additionally, by considering Figure 7 (b), the frequency is not constant over the entire pipe. The authors believe that from about 250 feet to 400 feet below the surface was the “power-in” region at the fundamental excitation frequency. This covers a reduced velocity range of 5.5 to about 6. At less than 250 feet the amplitude begins to drop off, suggesting this is a traveling wave zone dominated by the waves generated in the “power-in” region. At less than 150 feet from the top the frequency becomes very erratic, indicating the presence of locally generated vibration mixed in with traveling wave energy from distant locations.

Using the same assumptions for material properties, as the Lake Seneca case, the WAFO rainflow counting method was used to calculate fatigue damage for the Gulf Stream test. Figure 10 shows the RMS stress distribution along the length

of the pipe as well as the fatigue damage along the length of the pipe. This is for the same case as shown in Figure 8.

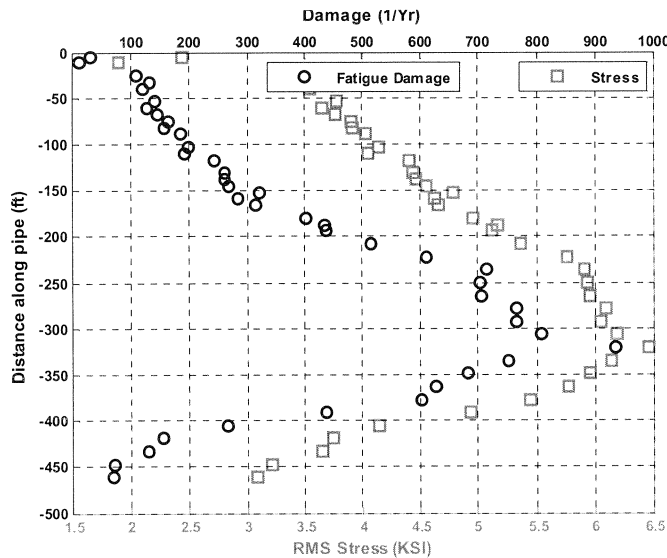

Figure 10 - RMS stress and total fatigue damage for an example from the Gulf Stream experiment

Fatigue Damage Due to 3x Component

The higher harmonics not only increase the RMS stress, as shown above, but these harmonics also increase the fatigue damage rate on cylinders subjected to VIV. One way to compare the relative importance of the fundamental and third harmonic contributions to fatigue damage rate is to compute the ratio of the damage rate which arises from the unfiltered signal to the damage rate which arises from the frequency components at the fundamental. This is shown in the following equation:

$$\frac{D_T}{D_{1X}} = \frac{\text{Total Damage}}{\text{Damage due to vibration at 1x frequency}}$$

A large value of this ratio indicates that the higher harmonics are important for fatigue damage calculations while a small ratio means that they are relatively unimportant.

The values of this ratio are shown for the Lake Seneca test example in Figure 11. The values indicate the total fatigue damage was twenty to forty times more than the fatigue damage due to the fundamental frequency. Earlier in the paper this ratio was estimated to be at least ten.

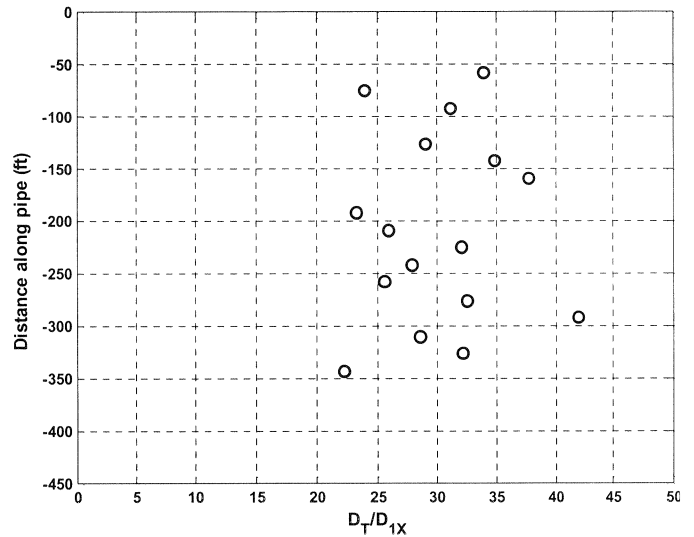

Figure 11 - Ratio of total damage to the damage from the fundamental frequency versus depth as seen in the Lake Seneca experiment

The Lake Seneca test was essentially uniform flow. The cross-flow frequency content was similar over the entire pipe length. Therefore, the ratio of total damage to the damage of the fundamental frequency was simple to calculate. However, for the Gulf Stream experiment in regions distant from the dominant “power-in” zone, the fundamental frequency component is difficult to separate from the higher harmonics. Figure 8 (a) shows the strain spectrum for such a location. For this reason, the authors have found that only in the ‘power-in’ zone, where local response dominates, does it make sense to compare the damage rate contributions from the fundamental frequency to that of the higher harmonics.

Figure 8 (b) shows the spectrum of the response at a point in what the authors believe to be the “power-in” region. For this example test, the ratio of the total damage rate to the damage rate which is associated with the fundamental peak only was between 25 and 35 at various sensors in the “power-in” region near $x/L = 0.75$. This is similar to the results seen the uniform flow cases at Lake Seneca.

THE SOURCE OF THE HIGHER HARMONIC EXCITATION

As shown above, significant 3x harmonics response is seen in the response data at both Lake Seneca and the Gulf Stream. The presence of the 3x harmonic component dramatically increases the fatigue damage rate. This section will give a potential hydrodynamic explanation of the origin of the third harmonic.

Recently, Jauvtis and Williamson [5] studied VIV for spring mounted cylinders having relatively low mass ratios (<6) and two degrees of freedom. They found the excitation at the 3x harmonic is associated with the shedding of three vortices in the wake behind the cylinder during each VIV half

cycle. They call this the '2T' mode of vortex shedding. They report that the switch to the 2T mode happens around reduced velocities of 5 and persists until reduced velocities of 8. They observed large A_y/D_0 ratios associated with the 2T mode and call it the SuperUpper (SU) region in the plot of A_y/D_0 versus reduced velocity. The 2T mode is associated with a relatively large third harmonic lift force component in the cross-flow direction.

Figure 12 shows Jauvtis and Williamson's A_y/D_0 versus reduced velocity data. This plot has been constructed from data shared by Williamson. The horizontal axis is reduced velocity based on the observed vibration frequency. The data is the same as that presented in reference [5], except that in [5], the data is plotted using a reduced velocity based on the still water natural frequency. In order to compare the Jauvtis and Williamson data to our observations the reduced velocity must be expressed in terms of observed response frequency, as in Figure 11. The region labeled as SU is the response branch associated with a strong 3x harmonic force component.

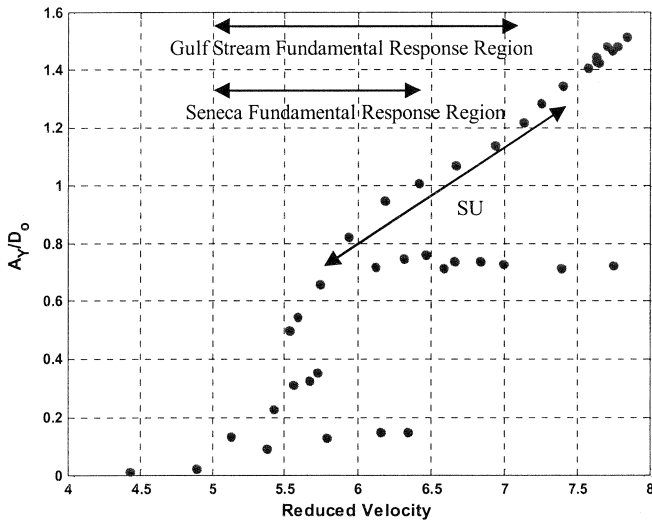

Figure 12 - The SuperUpper (SU) region where the '2T' mode of vortex shedding is found [5]. Also shown are possible "power-in" ranges for the fundamental and 3rd harmonics as observed in the Lake Seneca and Gulf Stream Tests

There are many similarities between the Jauvtis and Williamson and the Lake Seneca and Gulf Stream experiments. Both the Lake Seneca and Gulf Stream tests allowed two dimensional responses in the cross-flow and in-line directions. The test pipes had low mass ratios and sub-critical Reynolds numbers.

The Lake Seneca tests were conducted in a more controlled test environment due to the nearly constant current profile. At Lake Seneca the reduced velocities, based on response frequency, were between 4.5 and 6.5. In the vertical sections of the pipe most likely to be the source of the dominant excitation frequency the reduced velocity was 5 to 6.5. The Gulf Stream test saw more varied reduced velocities, ranging from 3 to 7. In

the areas with high RMS response, the reduced velocities were 5.5 to 7.

In Figure 12 the range of reduced velocities observed at Seneca is indicated by a double headed arrow from 4.5 to 6.5. The second arrow from 5.0 to 7.0 indicates the reduced velocity range observed in the Gulf Stream test associated with high RMS response and significant 3x strain contribution. These ranges overlap substantially with the Jauvtis and Williamson SU region, which has significant 3x lift force components. This suggests that a possible excitation mechanism for the observed response in the Lake Seneca and Gulf Stream experiments is the same as described by Jauvtis and Williamson.

Jauvtis and Williamson have measured a large 3x harmonic component in the SU region; this was where the "2T" wake formation is seen. The cross-flow lift force associated with the SU region is periodic at the fundamental VIV frequency, but is not sinusoidal. A Fourier series of this periodic lift force would have a sizable 3x harmonic, as seen in their data.

CONCLUSIONS

Since the 1980s, researchers have noticed higher harmonics in VIV related field experiments. In particular, vibrations at three times the fundamental VIV frequency have been noticed in the cross-flow direction. However, only recently have Jauvtis and Williamson [5] proposed a hydrodynamic explanation for their existence. Further, the existence of these higher harmonics has not been studied in realistic current environments. Nor has their effect on offshore pipelines and risers been studied in detail

Experiments done at Lake Seneca and in the Gulf Stream provide some of the first data sets of high mode number VIV response in realistic current environments. The Lake Seneca experiments were done for uniform current profiles and the Gulf Stream experiments had sheared current profiles. Both sets of experiments clearly show the presence of higher harmonic vibrations in addition to vibrations at the fundamental VIV frequency. The Gulf Stream experiments showed the contribution to the total RMS stress from the higher harmonics was more than 50% in the areas of high RMS stress.

An important consequence of this finding is the increase in fatigue damage for offshore oil and gas pipelines and risers that are subject to strong currents. These results show that the 3x frequency response component causes twenty to forty times the fatigue damage of the fundamental frequency of cross-flow vibration.

At present, the VIV prediction programs used by the offshore oil and gas industry only account for VIV corresponding to the fundamental frequency. These findings indicate the importance of including the effects of the higher harmonics especially with respect to fatigue life. These results also indicate that the greatest impact of the higher harmonics is for risers with VIV at high mode numbers. The closely

spaced natural frequencies ensure resonant behavior at the higher harmonics. Deepwater risers may be at greatest risk due to their high mode number response.

An obvious question is that if the offshore industry has been significantly underestimating fatigue damage due to VIV, why have there not been numerous fatigue related failures of risers? Several factors may have helped. The most important reason is high safety factors are built into the VIV analysis. DNV [8] recommends a factor of 10 to 15 and most industry analysts are even more conservative in their design. To add to this, predictive programs, like SHEAR7, give conservative estimates to compensate for the incomplete understanding of the VIV phenomena. The prevalent use of VIV suppression devices, like strakes, in deepwater risers may also be an important reason for the good performance of risers currently in the field. Even partial coverage of strakes had a dramatic effect on the reduction of the 3x harmonic in these experiments. [9]

Our data also shows that the 3x component is most important over rather narrow reduced velocity bands. Most response predictions have conservatively assumed much broader reduced velocity bandwidths when making fatigue estimates.

These conclusions are based on the tests conducted at sub-critical Reynolds numbers. The existence of the 3x response at full scale Reynolds numbers needs to be established.

NOMENCLATURE

A	<i>A material constant used in SN curves [force/length²]</i>
A_y	<i>Cross-flow Amplitude [length]</i>
m	<i>Material Parameter that characterizes the slope of the fatigue SN curve [-]</i>
D	<i>Damage Rate [time⁻¹]</i>
D_o	<i>Outer Diameter [length]</i>
f	<i>Frequency [time⁻¹]</i>
f_v	<i>Fundamental frequency of vibration [time⁻¹]</i>
L	<i>Length of Pipe [length]</i>
U	<i>Current Speed [length/time]</i>
U_n	<i>Normal Incidence Current Speed [length/time]</i>

ACKNOWLEDGMENTS

This research was sponsored by the DEEPSTAR Consortium, the Office of Naval Research Ocean Engineering and Marine Systems program (ONR 321OE) and the SHEAR7 JIP. The authors wish to thank the crews of the NUWC Seneca Lake facility and of the R/V F. G. Walton Smith at the University of Miami Rosenstiel School of Marine and Atmospheric Science. The authors also thank Tom Walsh from Futurepipe and Matt Sell from Insensys for their on site support. We also appreciate the data and information provided by Prof. Charles Williamson of the Sibly School of Mechanical and Aerospace Engineering at Cornell University.

REFERENCES

- [1] Vandiver, J. K., "Drag Coefficients of Long Flexible Cylinders", *Proc. 1983 Offshore Technology Conference*, Paper No. 4490, Houston, May 1983.
- [2] Vandiver, J.K. and Jong, J. Y., "The Relationship Between In-line and Crossflow Vortex-induced Vibration of Cylinders", *Journal of Fluids and Structures*, pp. 381-399, 1987.
- [3] Vandiver, J.K. and Chung, T-Y., "Predicted and Measured Response of Flexible Cylinders in Sheared Flow". *Proc., ASME Winter Annual Meeting Symposium on Flow-Induced Vibration*, Chicago, December 1988.
- [4] Vandiver and Marcollo "High Mode Number VIV Experiments", *IUTAM Symposium On Integrated Modeling of Fully Coupled Fluid-Structure Interactions Using Analysis, Computations, and Experiments*, pp. 211-231, Rutgers University, June 1-6, 2003, Edited by H. Benaroya & T. Wei, Kluwer Academic Publishers, Dordrecht.
- [5] Jauvtis, N., and Williamson, C. H. K., "The effect of two degrees of freedom on vortex-induced vibration at low mass ratio", *J. Fluid Mech.*, vol. 509, pp. 23-62, 2004
- [6] WAFO. Wave Analysis for Fatigue and Oceanography. Homepage, Lund Institute of Technology, March 2006
<<http://www.maths.lth.se/matstat/wafo/>>.
- [7] Vandiver, J. K., and Peoples, W. "The Effect of Staggered Buoyancy Modules on Flow-Induced Vibration of Marine Risers", *Proc. 2003 Offshore Technology Conference*, OTC-15284.
- [8] Det Norske Veritas, "Riser Fatigue", Recommended Practice DNV-RP-F204, Draft Version, August 2004.
- [9] Vandiver, Swithenbank, Jaiswel, and Marcollo "The Effects of Helical Strakes in the Suppression of High-Mode Number VIV" *Proc. 2006 Offshore Technology Conference*, OTC-18276-PP