

$N = 2$
 $d/\lambda = 0.1$
 $\phi = 0$

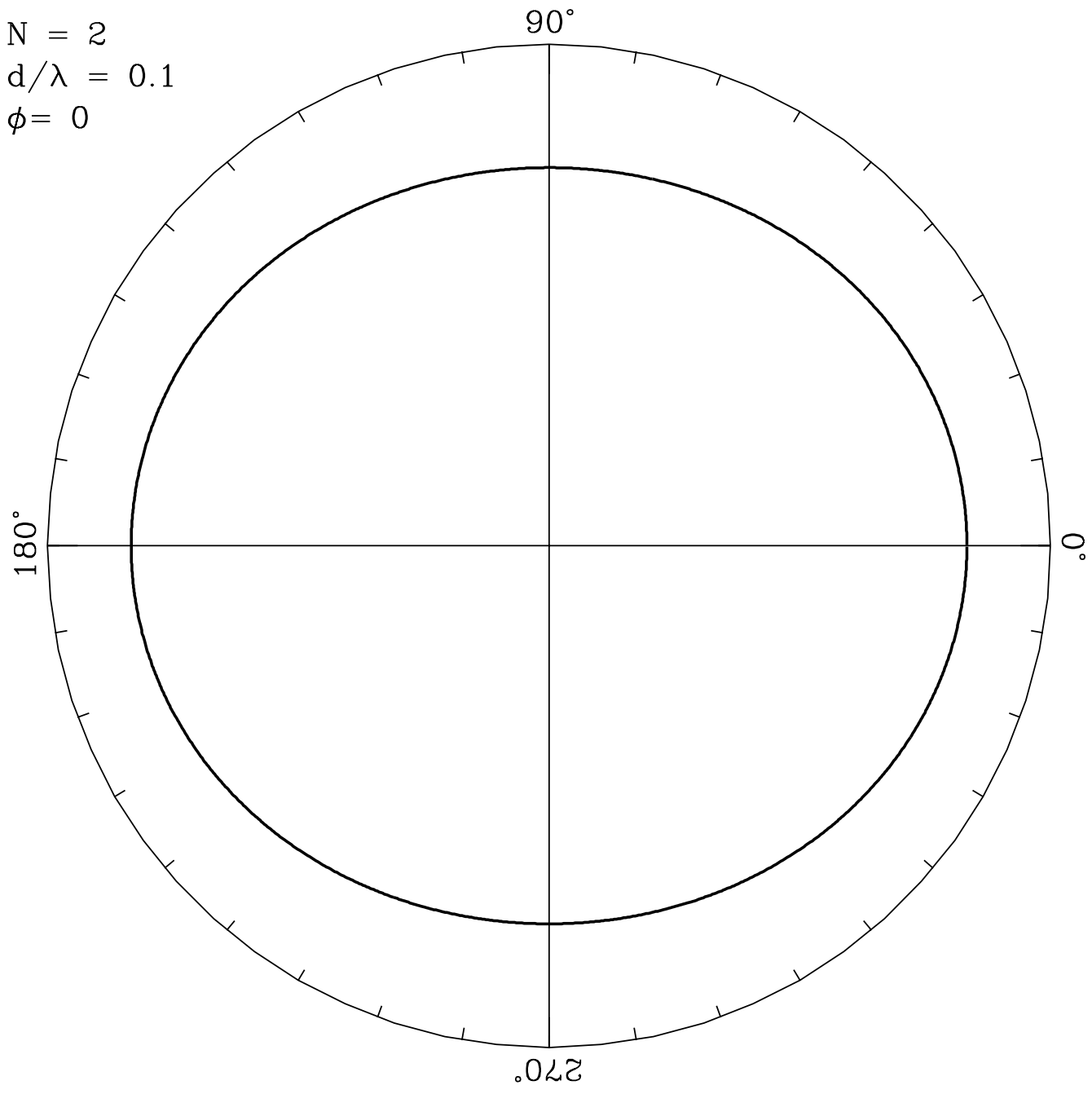

$N = 2$
 $d/\lambda = 0.25$
 $\phi = -0.5 \pi$

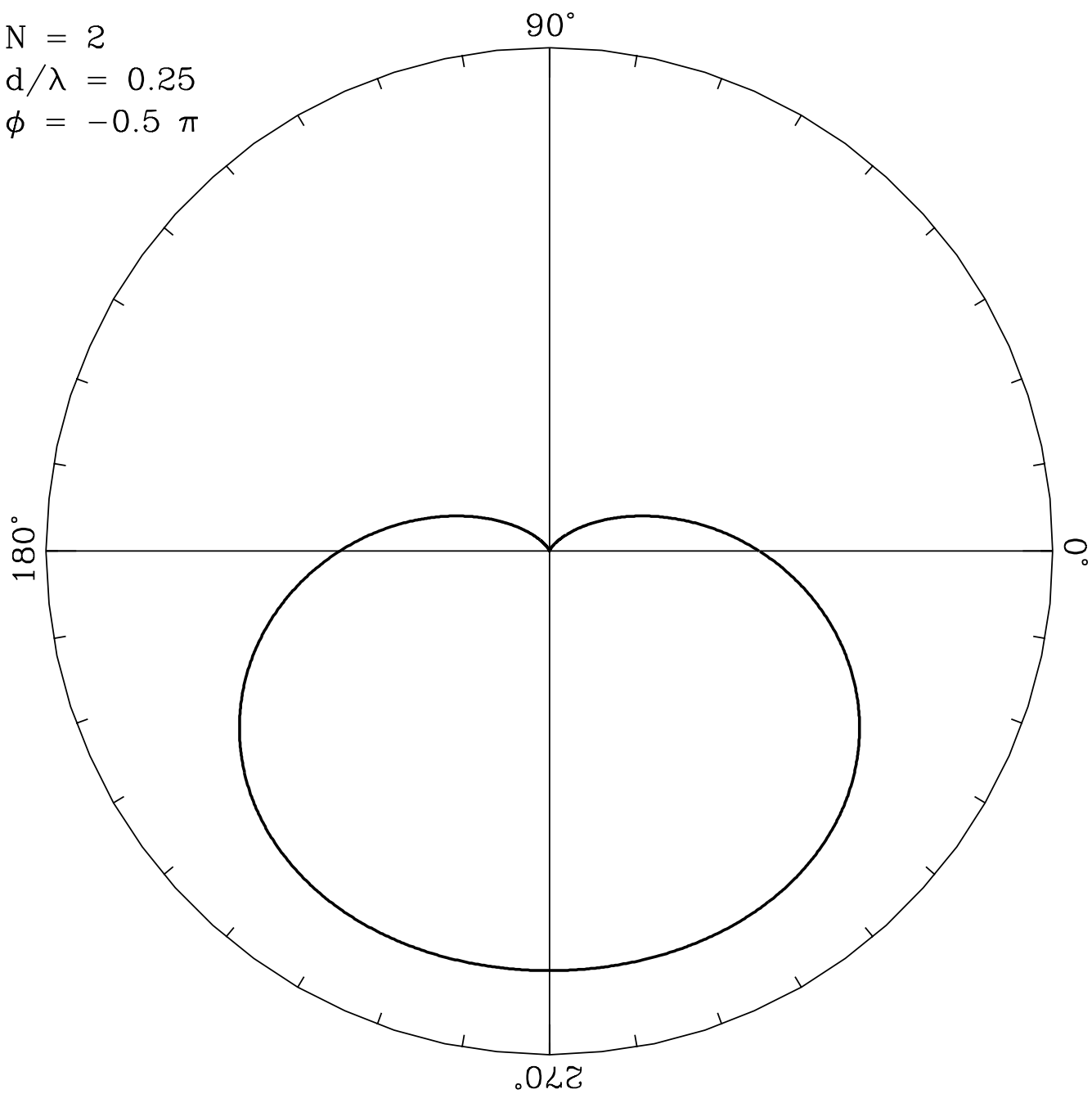

$N = 2$
 $d/\lambda = 0.25$
 $\phi = 0.5 \pi$

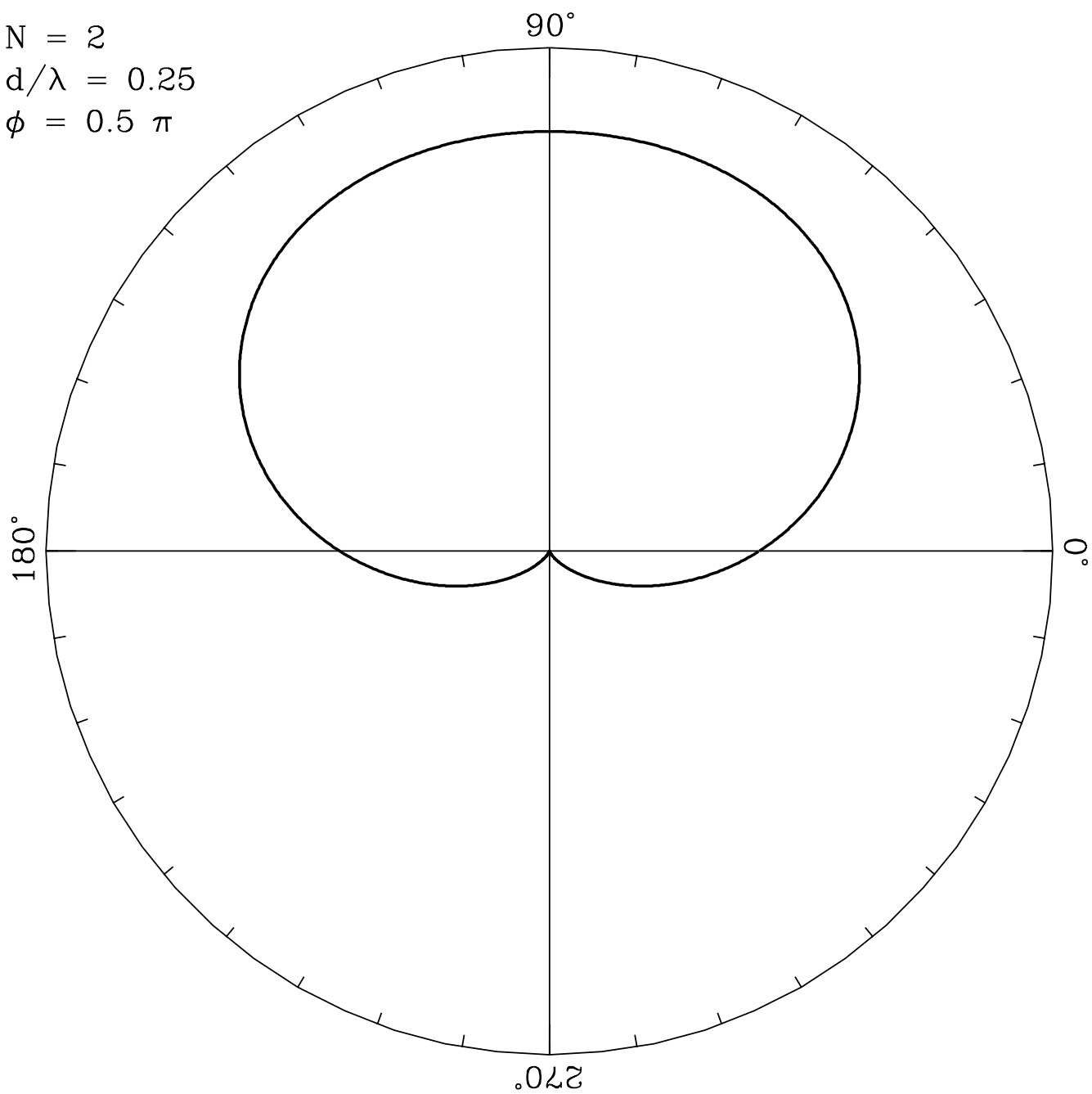

$N = 20$
 $d/\lambda = 0.5$
 $\phi = 0.5 \pi$

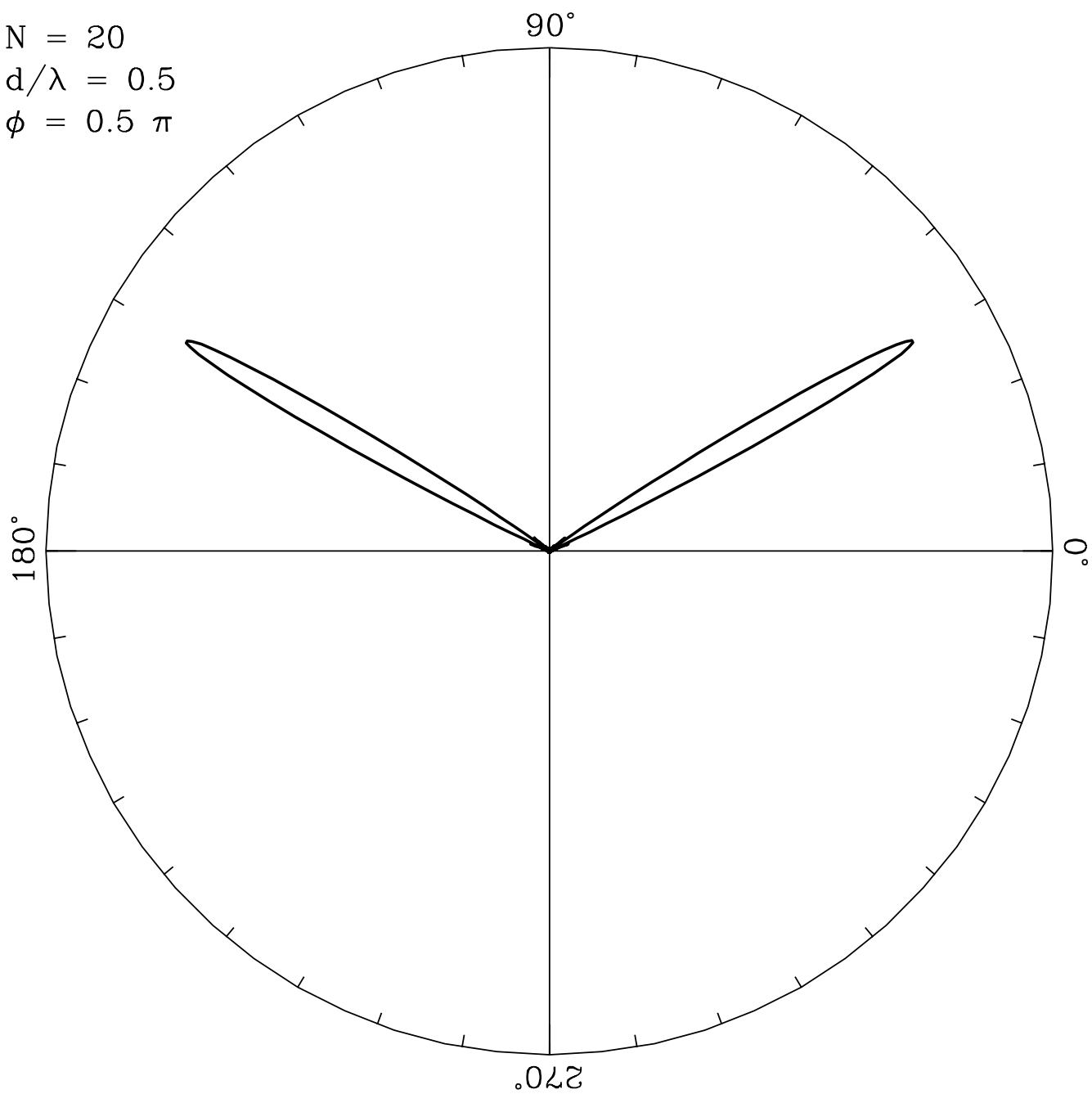

$N = 20$
 $d/\lambda = 0.5$
 $\phi = 0.95 \pi$

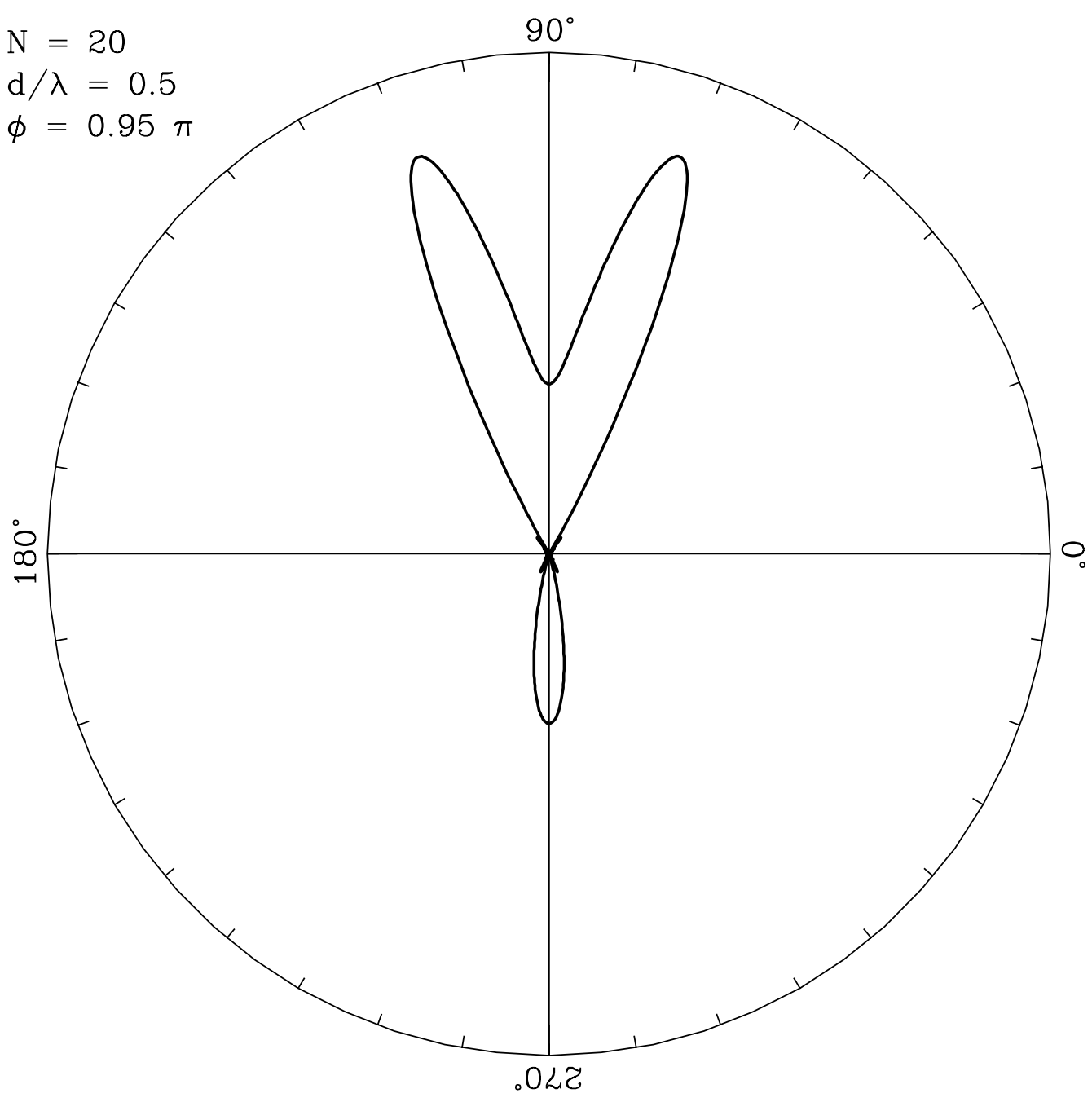

$N = 2$
 $d/\lambda = 0.5$
 $\phi = 0$

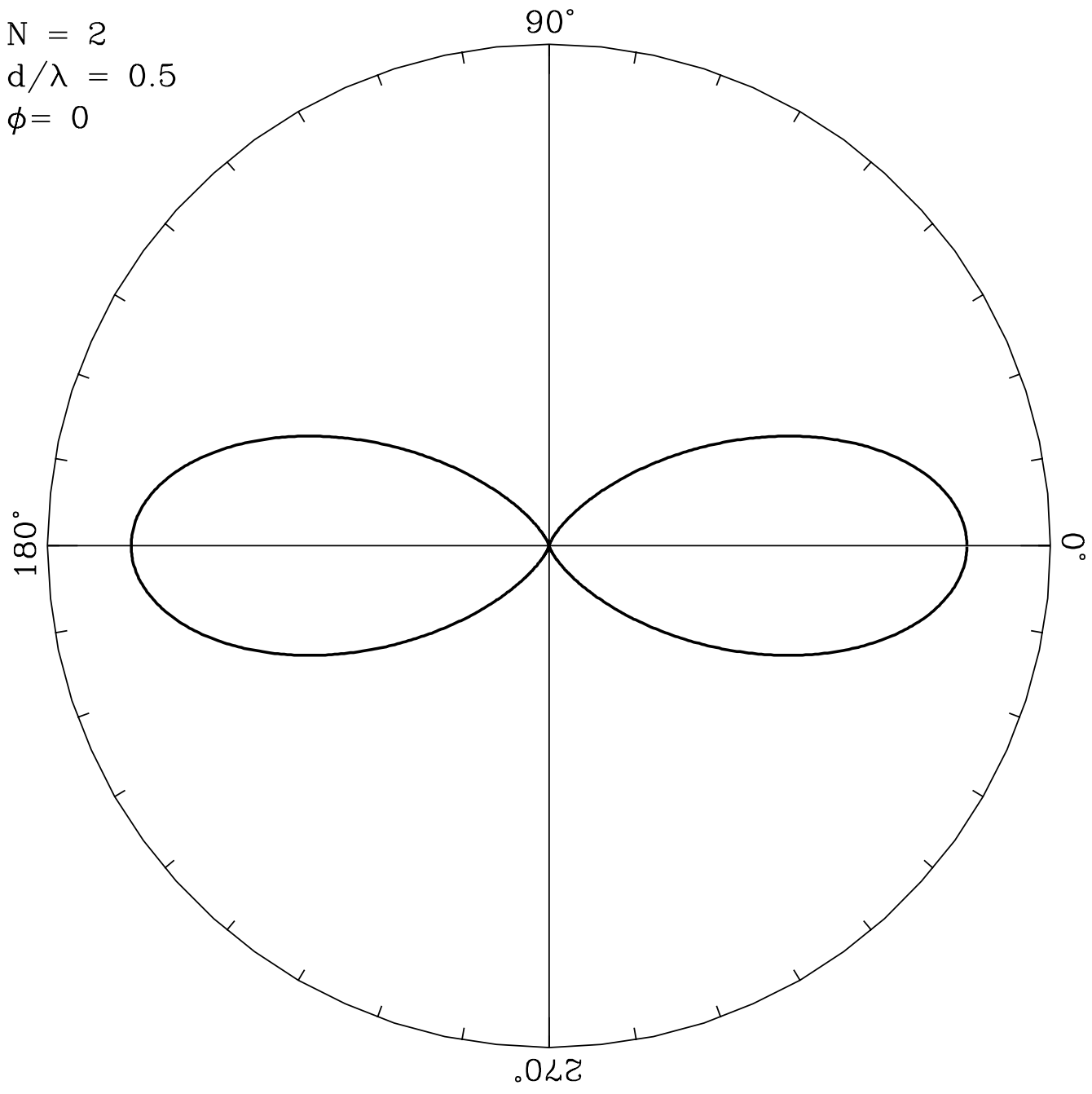

$N = 20$
 $d/\lambda = 0.5$
 $\phi = 0$

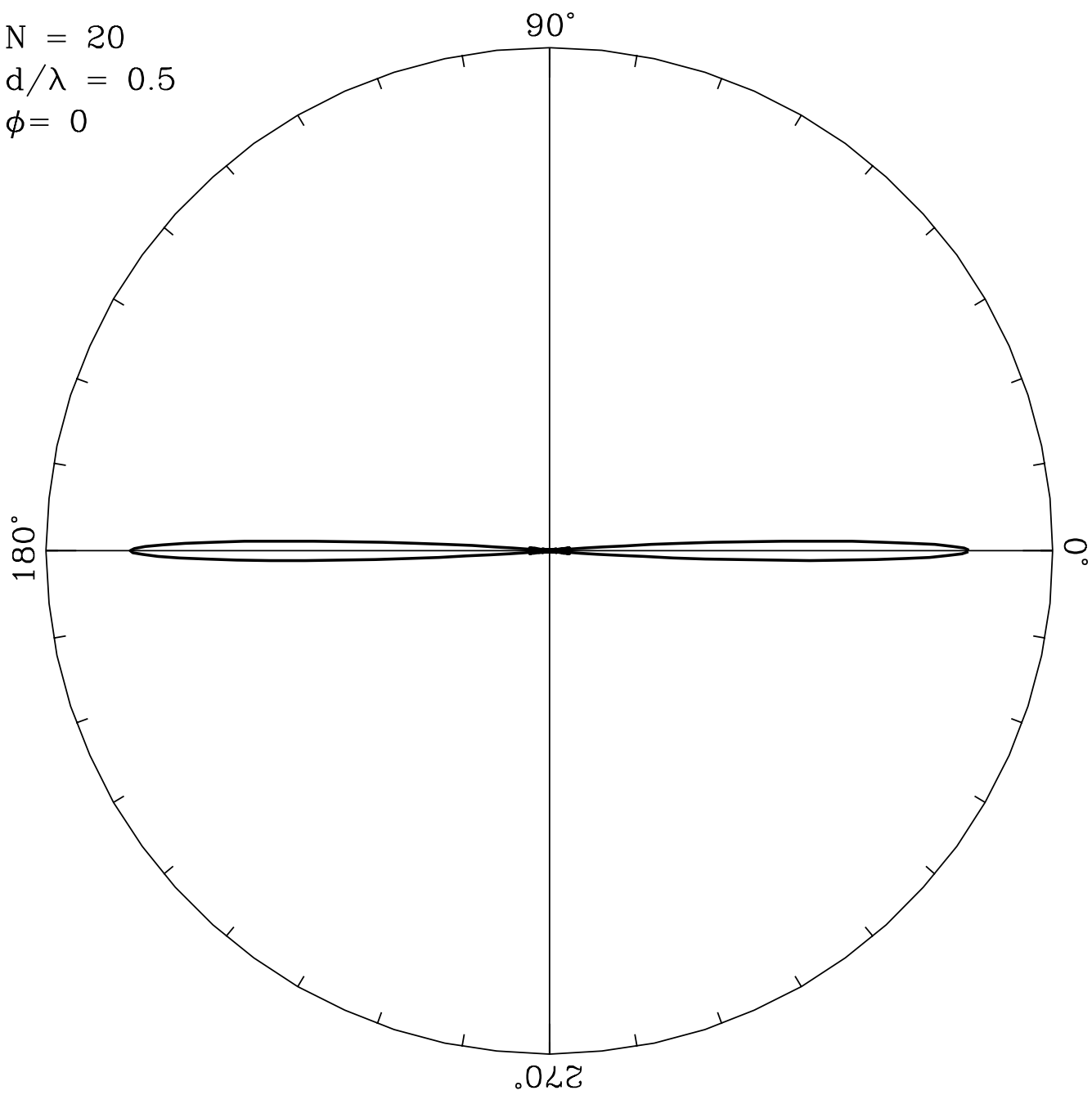

$N = 3$
 $d/\lambda = 0.5$
 $\phi = 0$

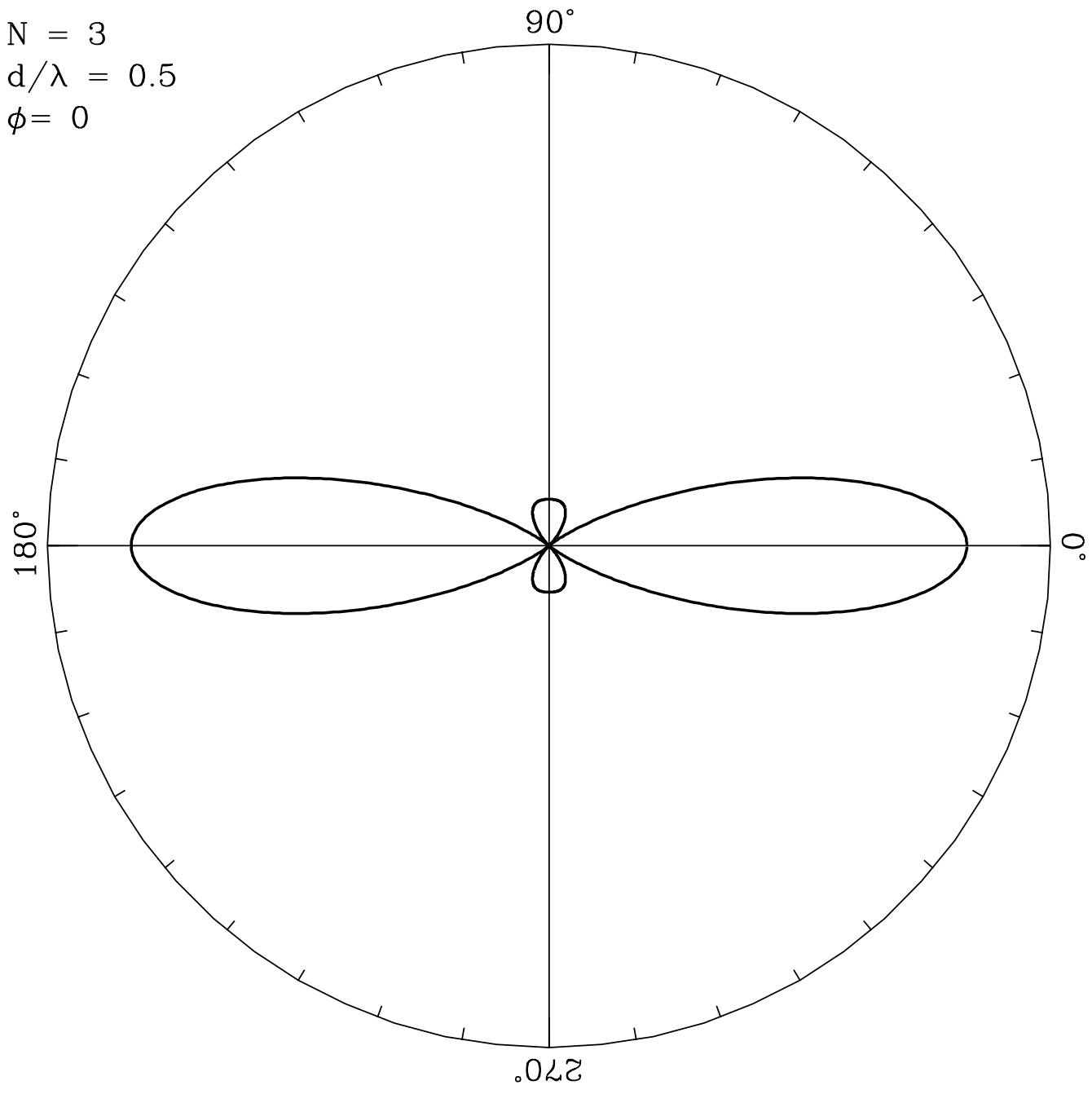

$N = 5$
 $d/\lambda = 0.5$
 $\phi = 0$

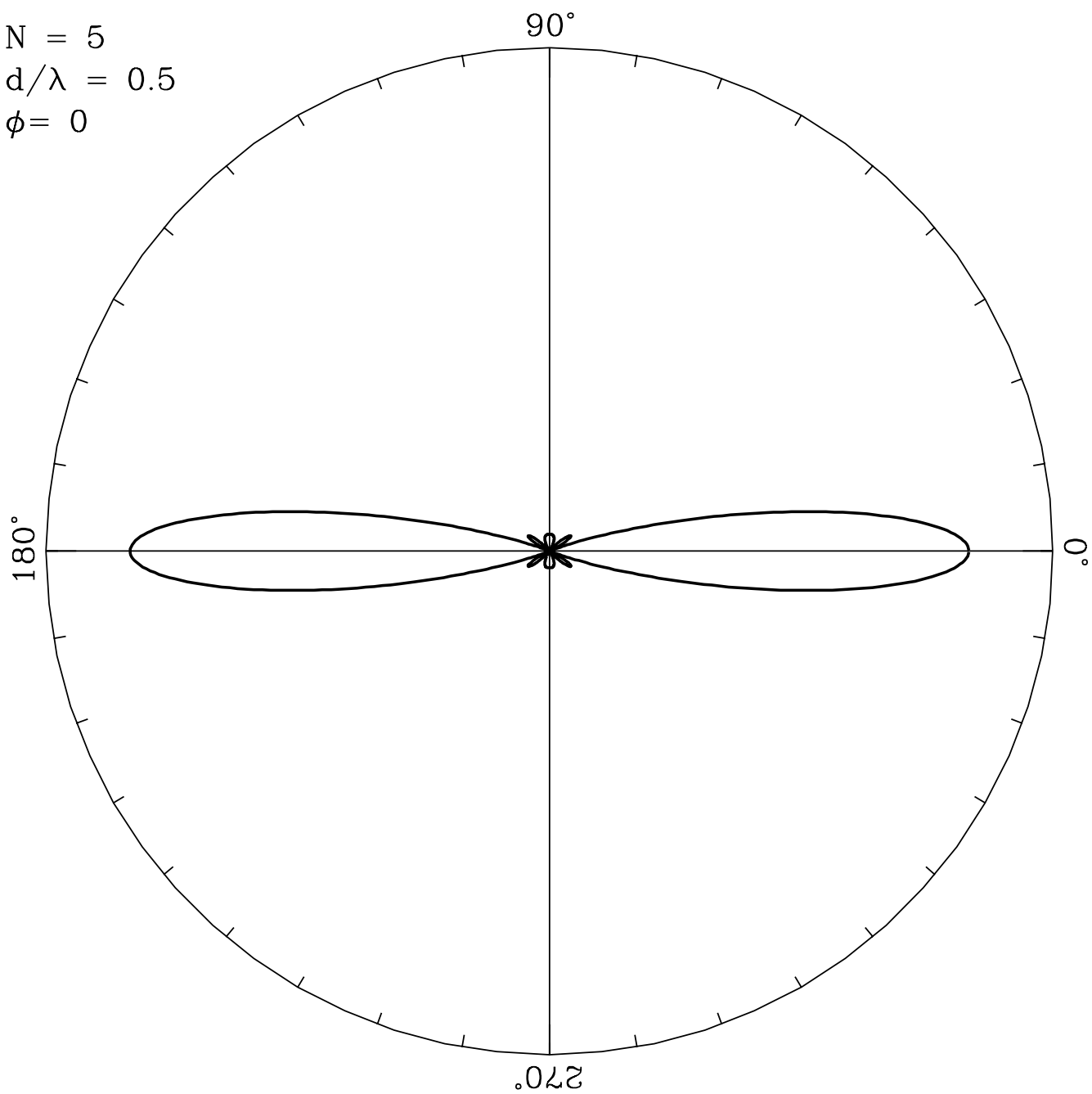

$N = 2$
 $d/\lambda = 1$
 $\phi = 0$

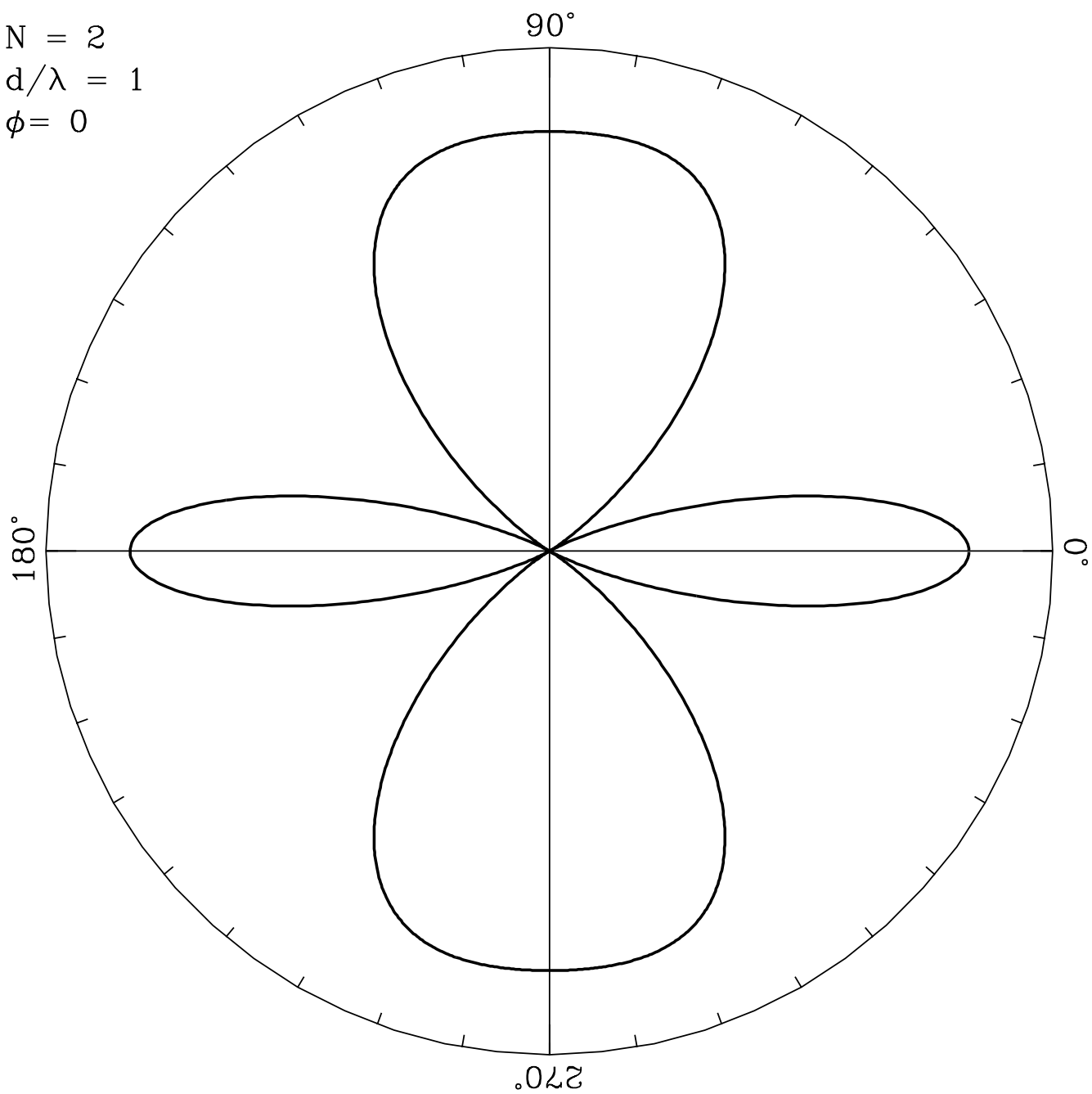

$N = 20$
 $d/\lambda = 3.5$
 $\phi = 0$

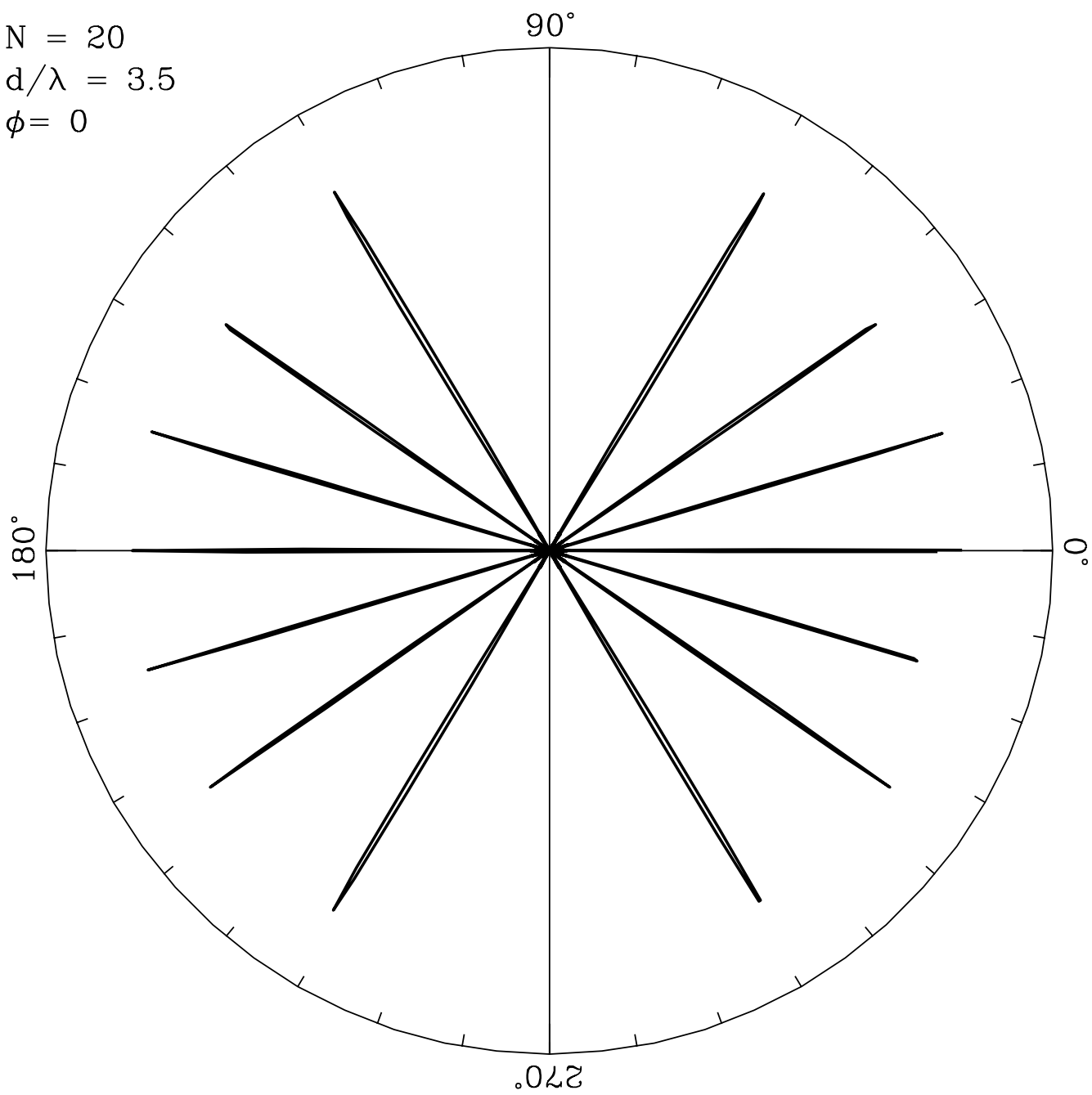

$N = 2$
 $d/\lambda = 5$
 $\phi = 0$

