

L14: Time & Ordering

Nickolai Zeldovich
6.033 Spring 2011

Physical oscillators

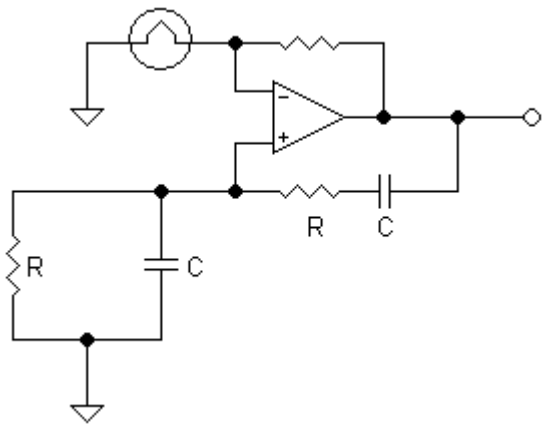

RC circuits

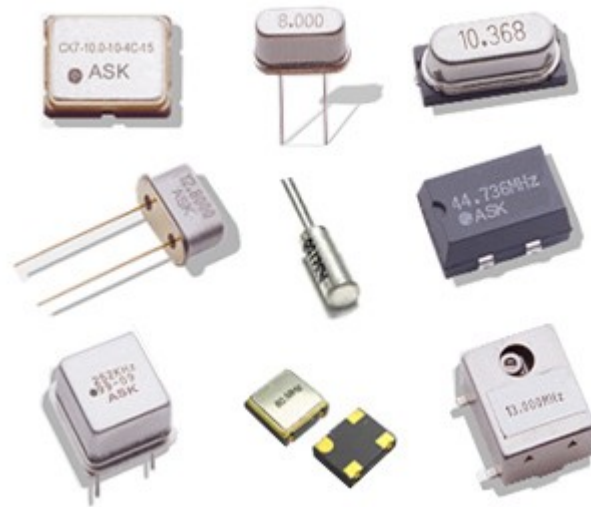

Quartz crystals



Cesium atoms

Reference clock



**US Naval
Observatory**

Reference clock



**US Naval
Observatory**



WWVB

Simple time sync protocol

```
sync(server):  
    t0 = local_time  
    tsrv = getTime(server)  
    t1 = local_time  
    delay = (t1-t0) / 2  
    offset = (t1-delay) - tsrv  
    local_time = local_time - offset
```



client

```
getTime():  
    return local_time
```



server

Slew time

sync(server):

t0 = local_time

tsrv = getTime(server)

t1 = local_time

delay = (t1-t0) / 2

offset = (t1-delay) - tsrv

freq = base + ϵ * sign(offset)

sleep(freq * abs(offset) / ϵ)

freq = base

} temporarily
speed up /
slow down
local clock

timer_intr(): # on every oscillator tick..

local_time = local_time + 1/freq

Adjust frequency estimate

```
sync_freq(server):
```

```
    t0 = local_time
```

```
    ts0 = getTime(server)
```

```
    sleep(N)
```

```
    t1 = local_time
```

```
    ts1 = getTime(server)
```

```
    ratio = (t1-t0) / (ts1-ts0)
```

```
    freq = freq * ratio
```

} set local
frequency
to match
server

```
timer_intr(): # on every oscillator tick..
```

```
    local_time = local_time + 1/freq
```

File reconciliation between computers A, B, and C

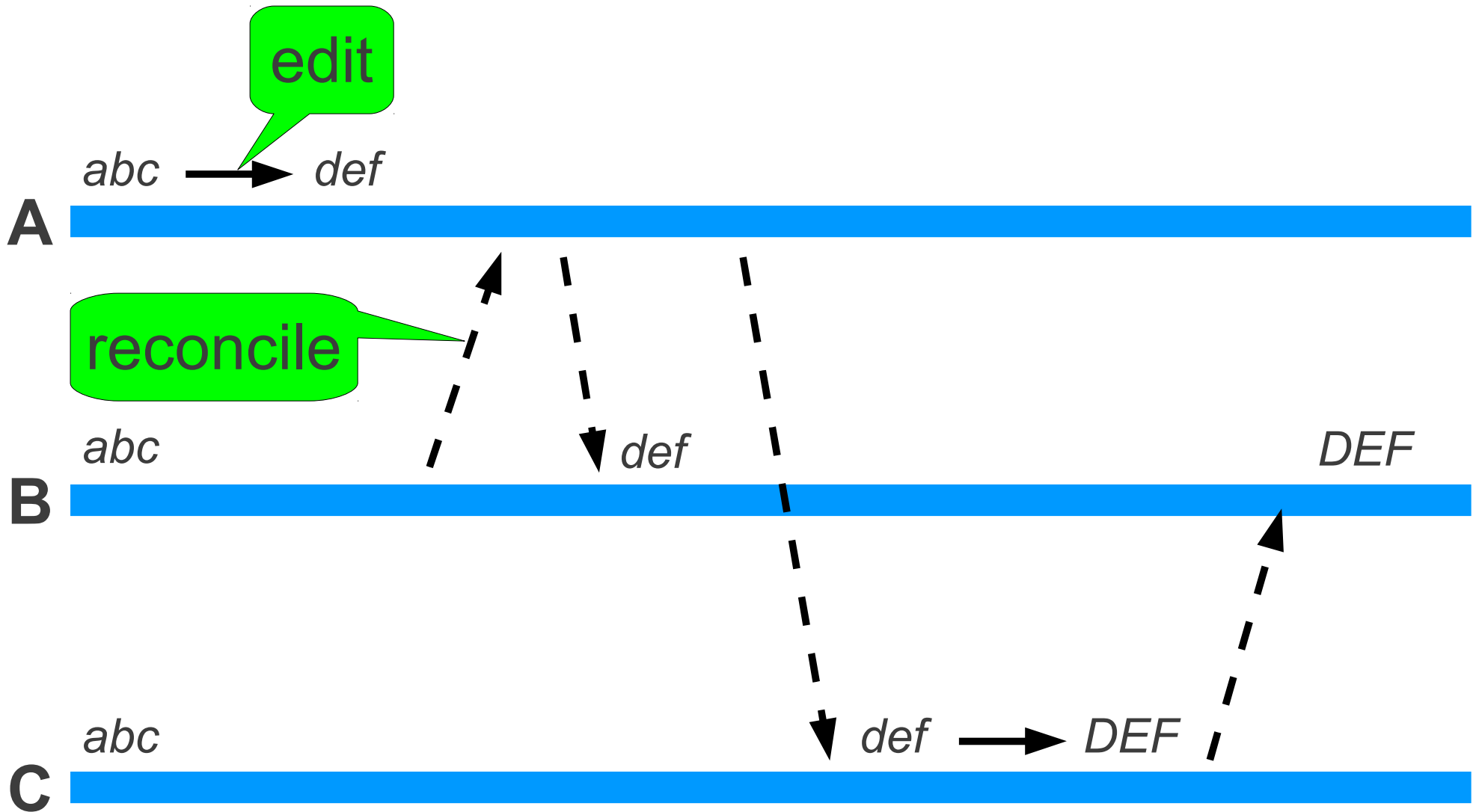

Reconcile based on timestamps

invoked on candidate file from remote machine

reconcile(remote):

 if local.modTime \geq remote.modTime:

 return

 local.data = remote.data

 local.modTime = remote.modTime

Reconcile based on timestamps

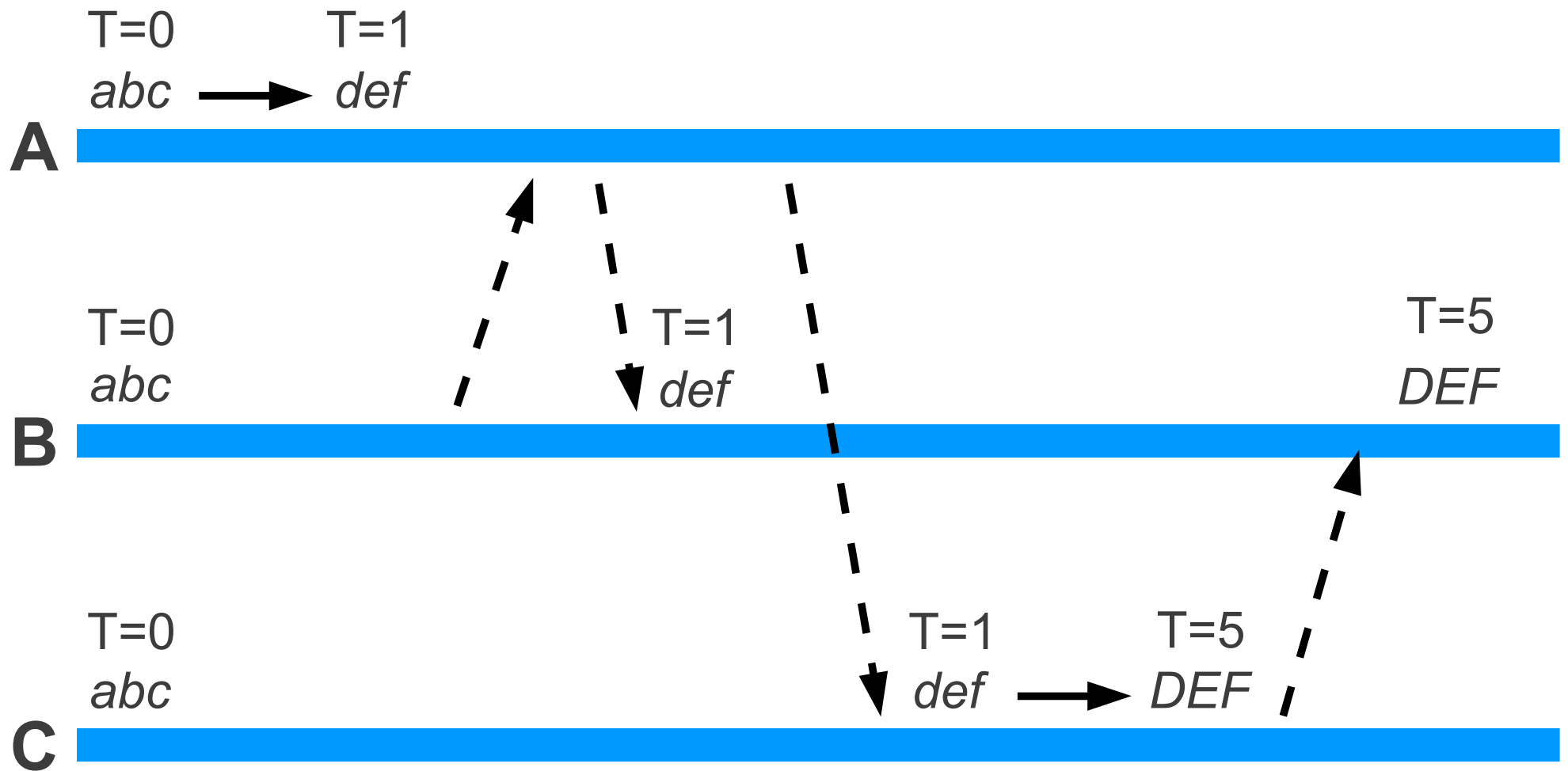

Problem: concurrent change lost

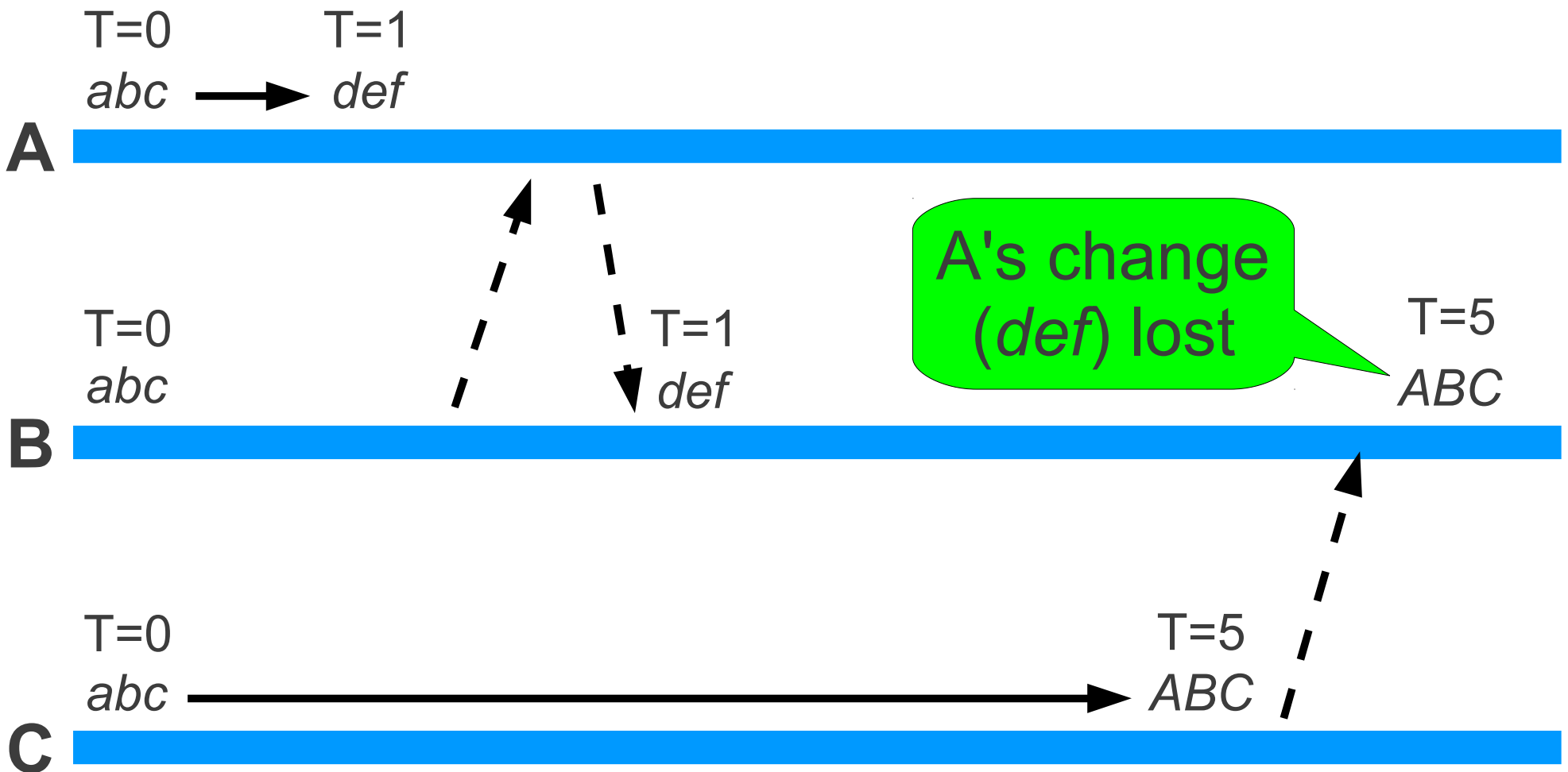

Vector timestamps

invoked on candidate file from remote machine

reconcile(remote):

if local.modTime[n] \geq remote.modTime[n], $\forall n$:
return

if local.modTime[n] \leq remote.modTime[n], $\forall n$:
local.data = remote.data
local.modTime = remote.modTime

else:

raise ReconcileConflict(local, remote)

Vector timestamps

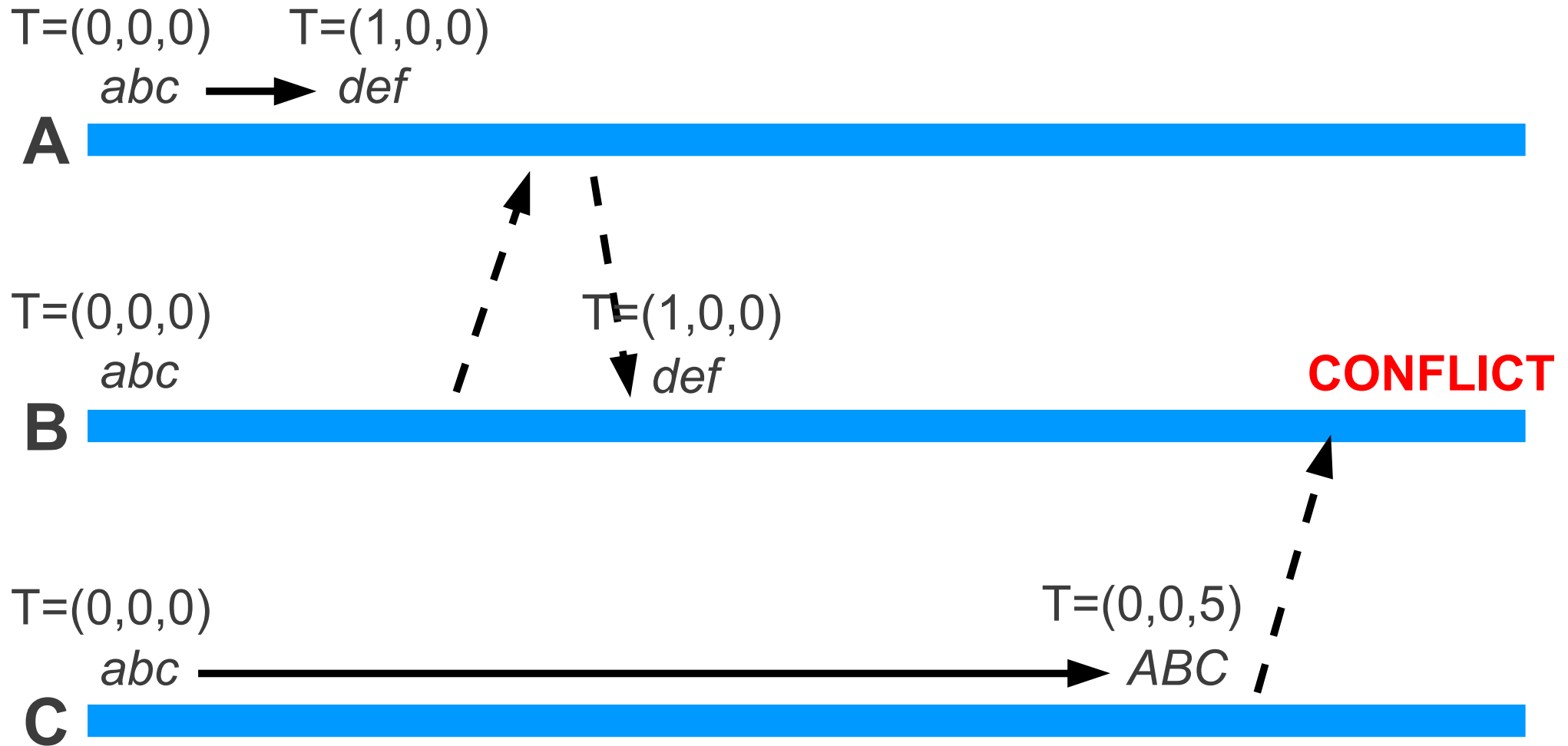

Vector timestamps

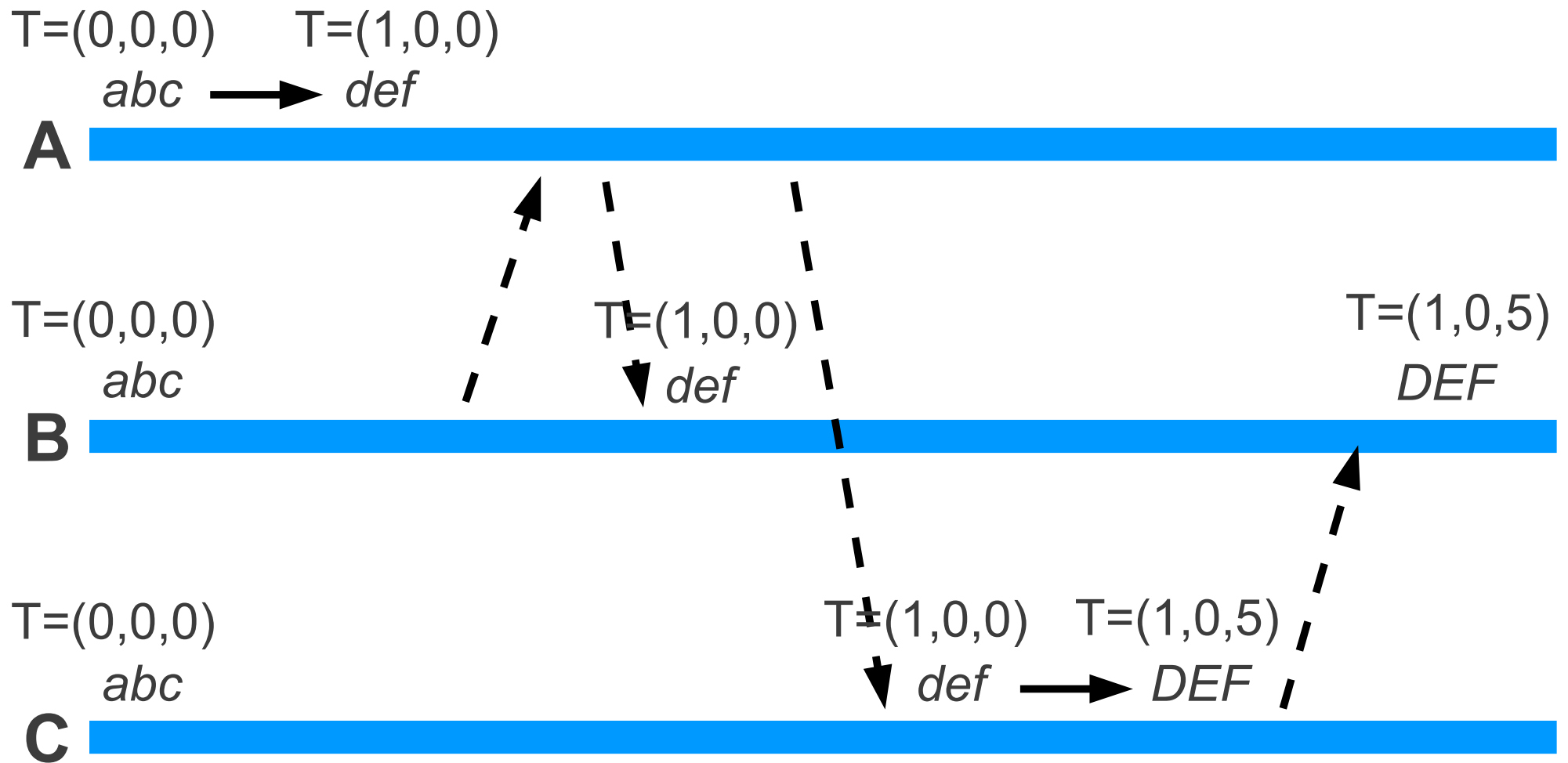

Vector timestamps: only local comparison

invoked on candidate file from remote machine
reconcile(remote):

if $\text{local.modTime}[n] \geq \text{remote.modTime}[n]$, $\forall n$:
return

if $\text{local.modTime}[n] \leq \text{remote.modTime}[n]$, $\forall n$:
local.data = remote.data
local.modTime = remote.modTime

else:

raise ReconcileConflict(local, remote)